

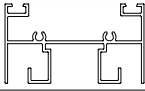

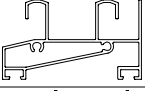

Corredera serie 800

Secciones y hoja de corte

Ventana de dos hojas correderas
marco guía de 132

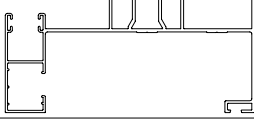
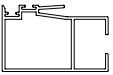
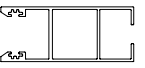
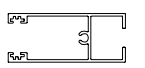
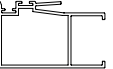
PERFIL	CODIGO	CORTE	MEDIDA
	800225	90°	A - 89 mm.
	800186	90°	A - 89 mm.
	800552	90°	= H
	800553	90°	= H
	800255	90°	H - 66 mm.
	800315	90°	H - 66 mm.
	800350	90°	A/2 - 45 mm.
	800260	90°	H - 66 mm.
	800320	90°	H - 66 mm.
	800360	90°	A/2 - 45 mm.

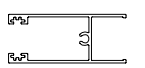
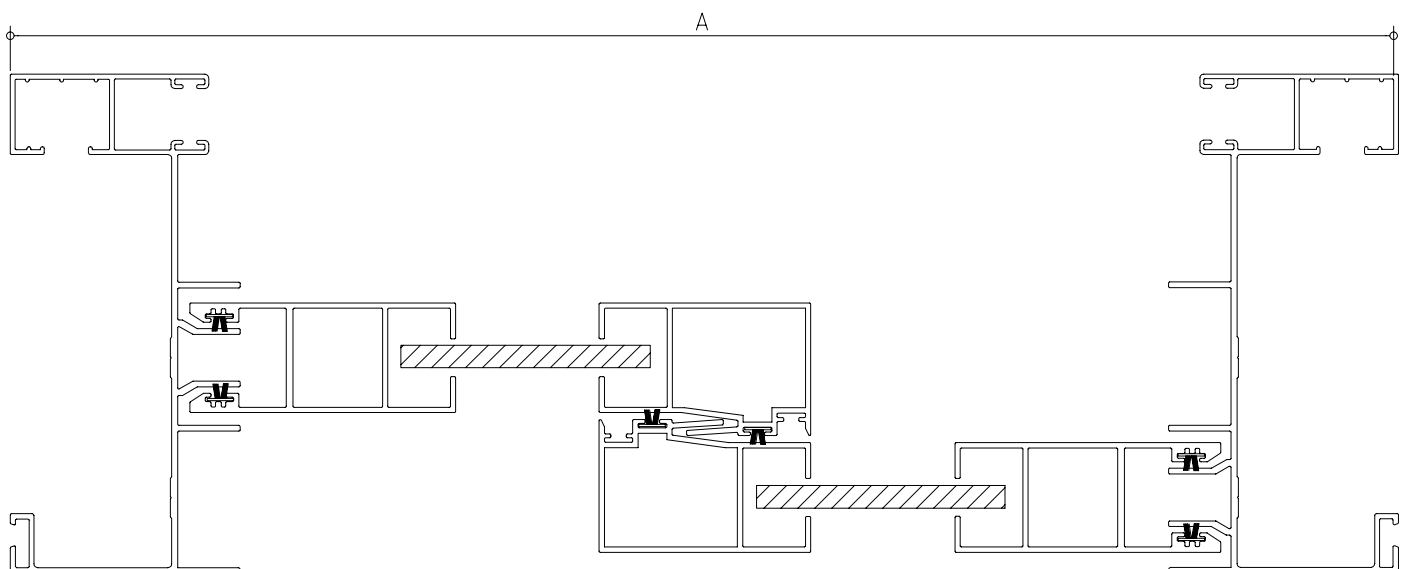
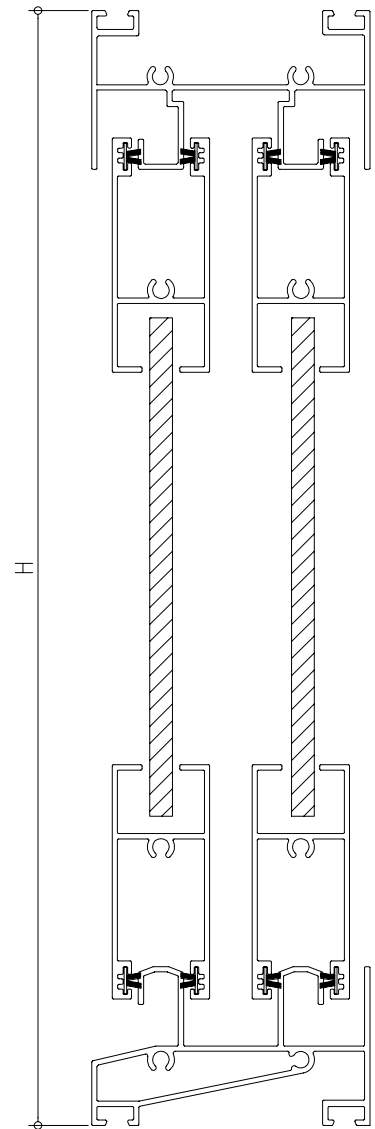

Corredera serie 800

Secciones y hoja de corte

Ventana de dos hojas correderas
con solape integrado

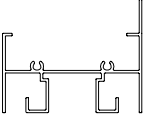
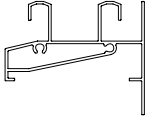
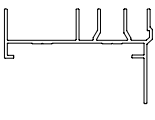
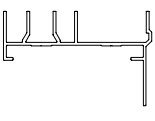
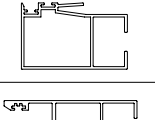
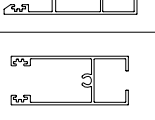
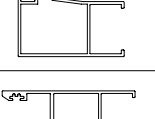
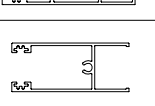
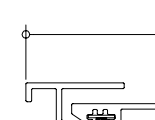
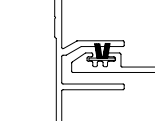

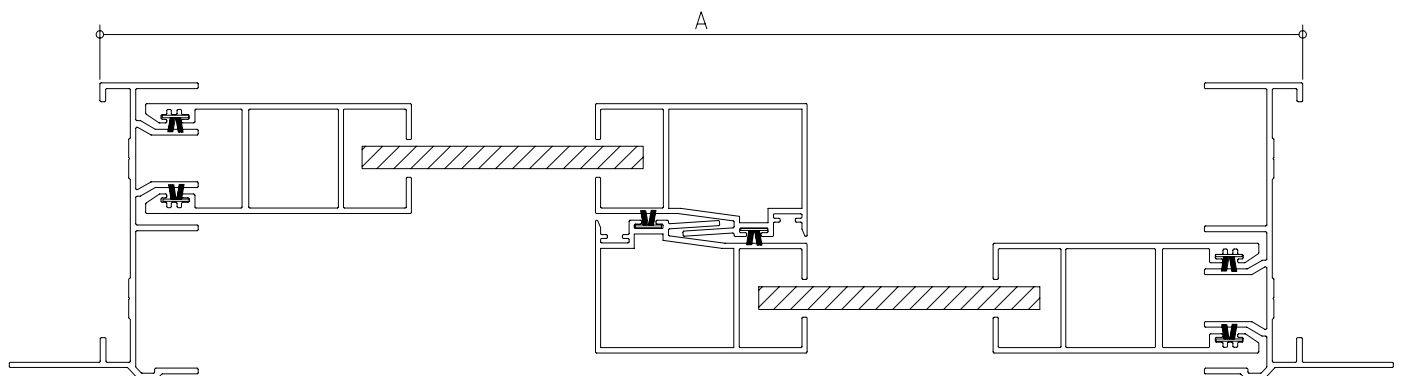
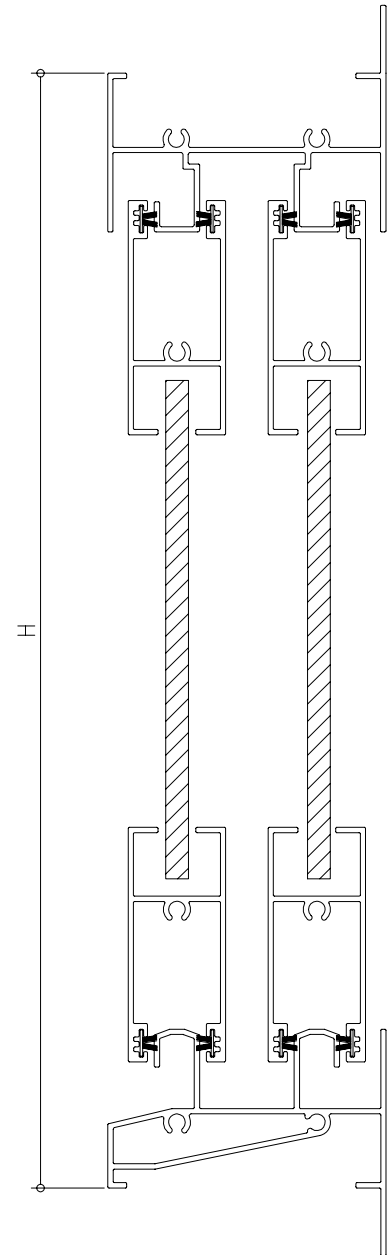



PERFIL	CODIGO	CORTE	MEDIDA
	800230	90°	A - 20 mm.
	800190	90°	A - 20 mm.
	800563	90°	H + 36 mm.
	800573	90°	H + 36 mm.
	800255	90°	H - 66 mm.
	800315	90°	H - 66 mm.
	800350	90°	A/2 - 12 mm.
	800260	90°	H - 66 mm.
	800320	90°	H - 66 mm.
	800360	90°	A/2 - 12 mm.

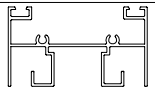
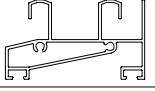

Corredera serie 800

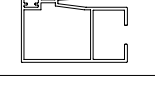
Secciones y hoja de corte

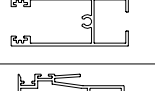
Ventana de dos hojas correderas

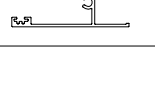
PERFIL	CODIGO	CORTE	MEDIDA
	800225	90°	A - 48 mm.
	800186	90°	A - 48 mm.
	800530	90°	= H
	800255	90°	H - 66 mm.
	800315	90°	H - 66 mm.
	800350	90°	A/2 - 26 mm.
	800260	90°	H - 66 mm.
	800320	90°	H - 66 mm.
	800360	90°	A/2 - 26 mm.

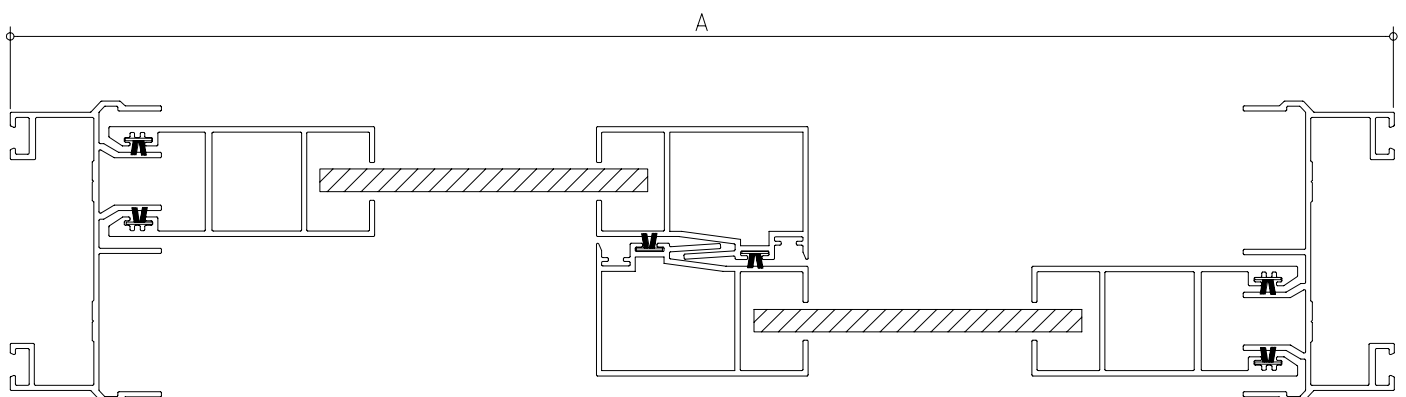
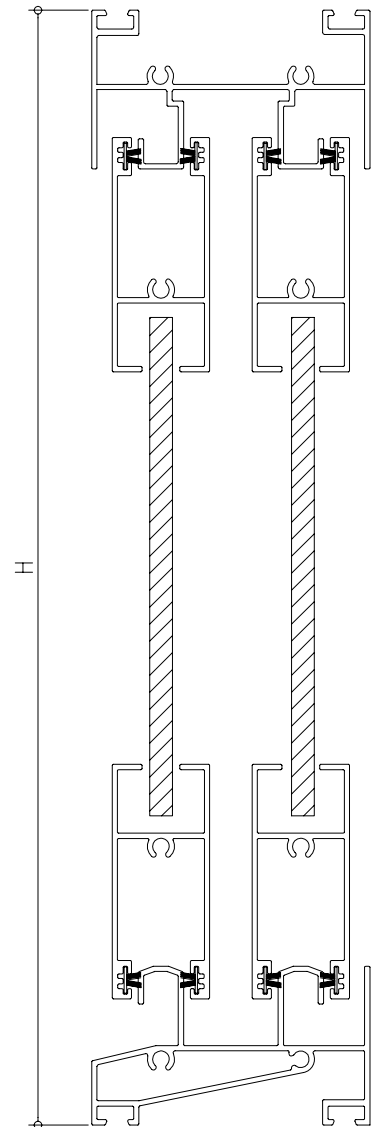

Corredera serie 800

Secciones y hoja de corte

Ventana de tres hojas correderas
con marcos para tres hojas

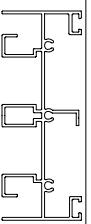
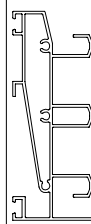
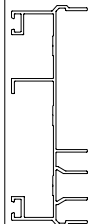
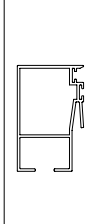
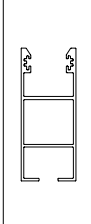
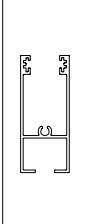
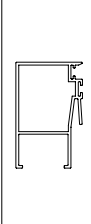
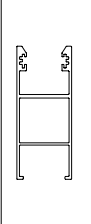
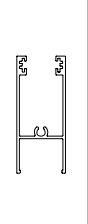

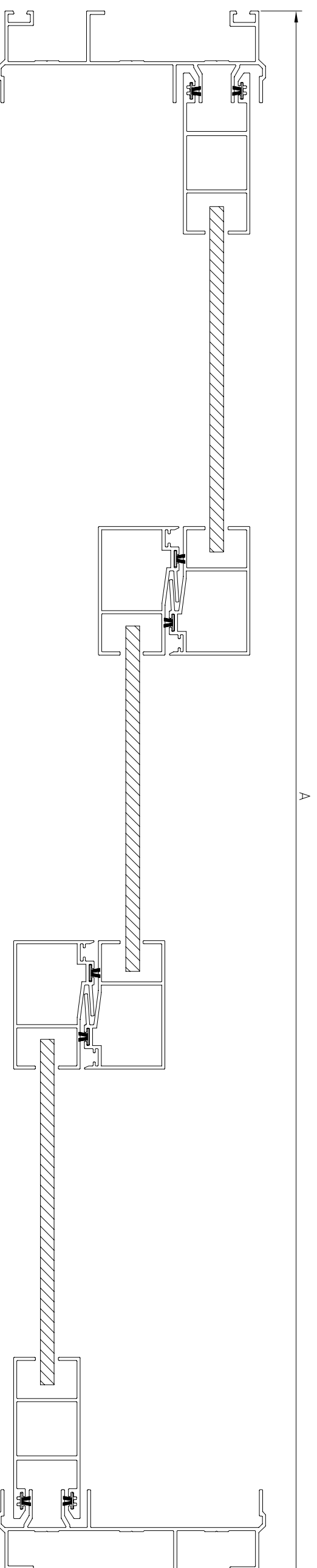
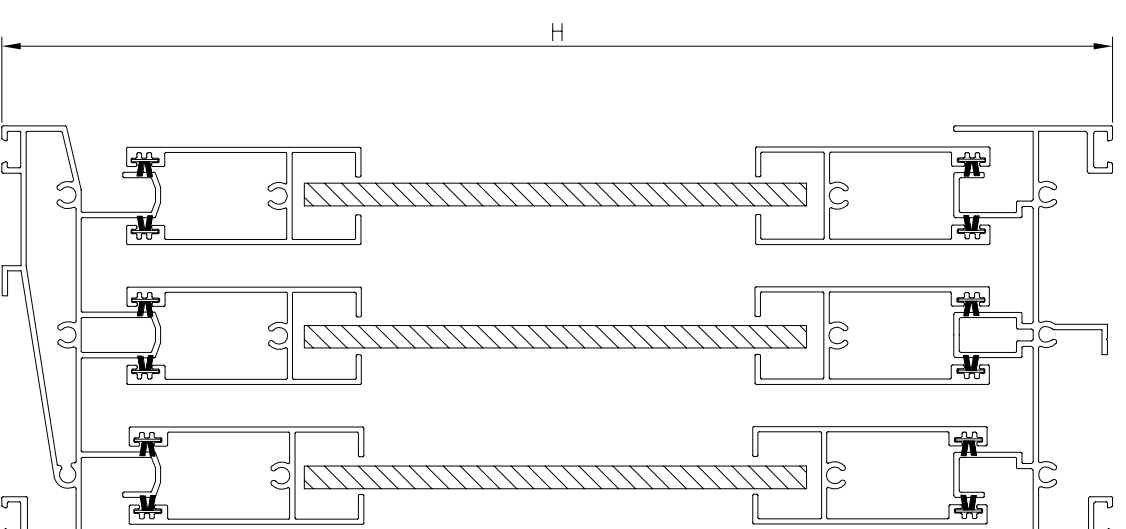
PERFIL	CODIGO	CORTE	MEDIDA
	800235	90°	A - 48 mm.
	800195	90°	A - 48 mm.
	800540	90°	= H
	800255	90°	H - 66 mm.
	800315	90°	H - 66 mm.
	800350	90°	A/3
	800260	90°	H - 66 mm.
	800320	90°	H - 66 mm.
	800360	90°	A/3



Corredera serie 800



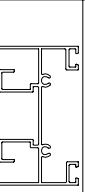

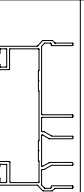
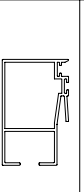
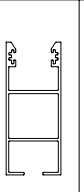
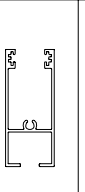
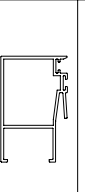
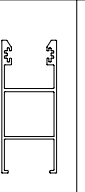
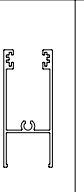
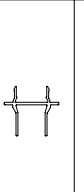

Secciones y hojas de corte

Ventana de cuatro hojas correderas

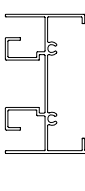
PERFIL	CODIGO	CORTE	MEDIDA
	800225	90°	A - 48 mm.
	800186	90°	A - 48 mm.
	800530	90°	= H
	800255	90°	H - 66 mm.
	800315	90°	H - 66 mm.
	800350	90°	A/4 - 15 mm.
	800260	90°	H - 66 mm.
	800320	90°	H - 66 mm.
	800360	90°	A/4 - 15 mm.
	800761	90°	H - 66 mm.

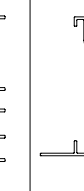
LAS COTAS "A,H" PARA ESTA HOJA DE CORTE CON MARCOS DE SOLAPE INTEGRADOS, SE ENTIENDEN SIN INCLUIR EL SOLAPE.

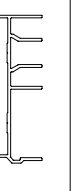
Ventana de cuatro hojas correderas con solape integrado

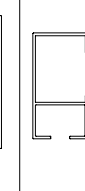
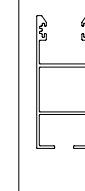
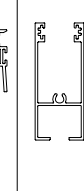
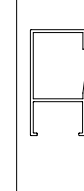

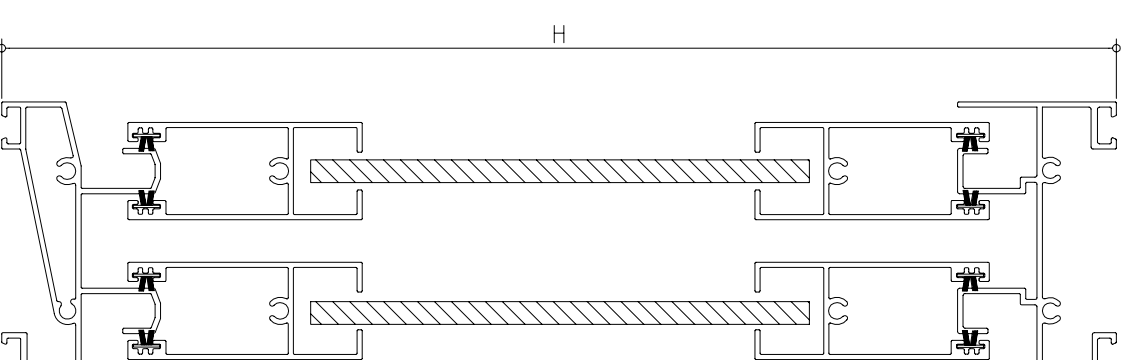
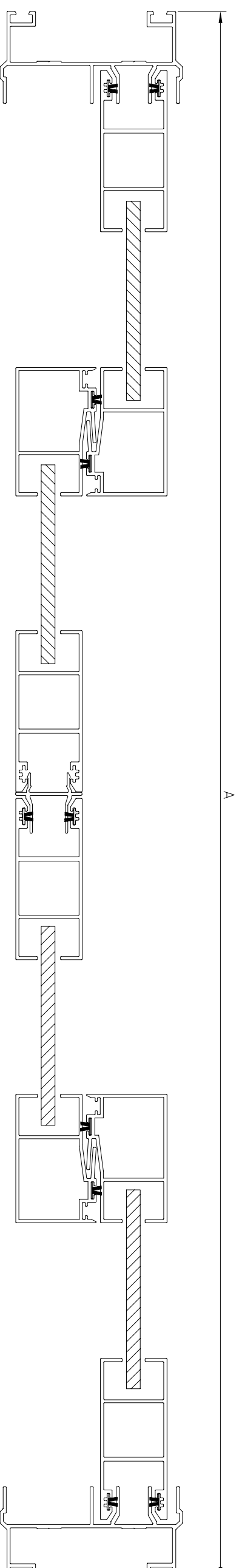

PERFIL	CODIGO	CORTE	MEDIDA
	800230	90°	A - 20 mm.
	800190	90°	A - 20 mm.
	800563	90°	H + 36 mm.
	800573	90°	H + 36 mm.
	800255	90°	H - 66 mm.
	800315	90°	H - 66 mm.
	800350	90°	A/4 - 8 mm.
	800260	90°	H - 66 mm.
	800320	90°	H - 66 mm.
	800360	90°	A/4 - 8 mm.

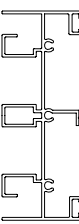
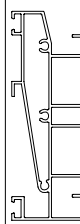
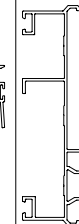

Corredera serie 800

Secciones y hoja de corte

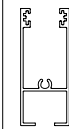
Ventana de seis hojas correderas
con marcos para tres hojas

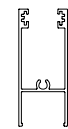
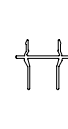
PERFIL	CODIGO	CORTE	MEDIDA
	800235	90°	A - 48 mm.
	800195	90°	A - 48 mm.
	800540	90°	= H
	800255	90°	H - 66 mm.
	800315	90°	H - 66 mm.
	800350	90°	A/6 + 8 mm.
	800260	90°	H - 66 mm.
	800320	90°	H - 66 mm.
	800360	90°	A/6 + 8 mm.
	800761	90°	H - 66 mm.

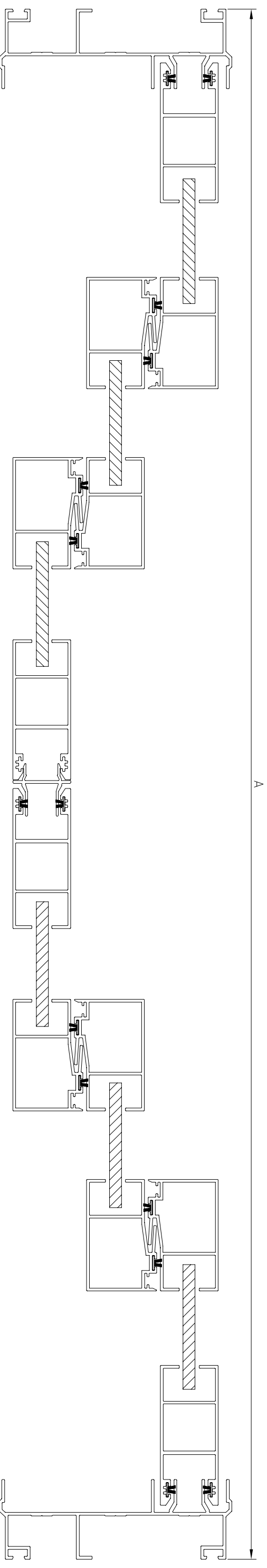
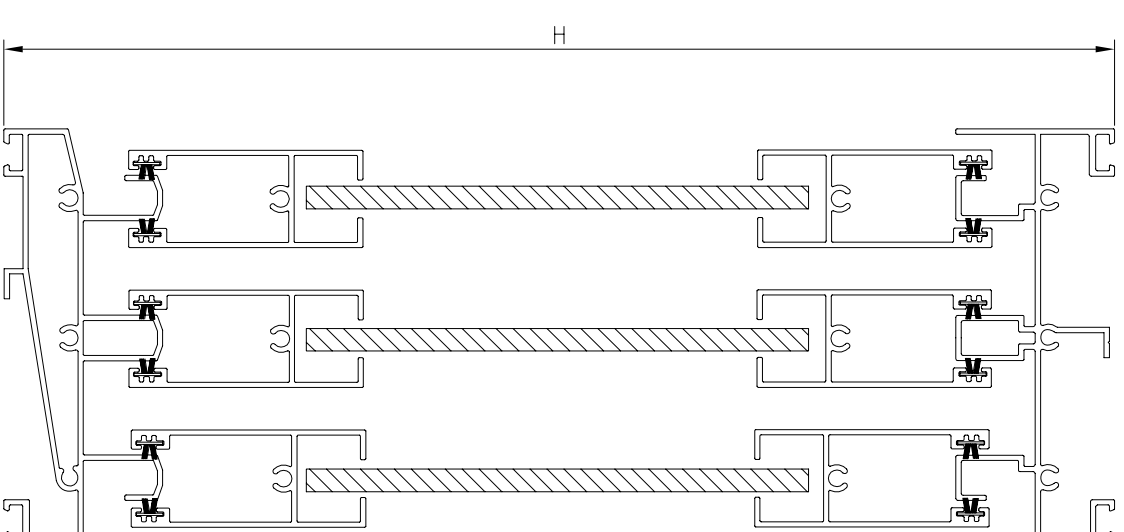

Corredera serie 800

Hojas climalit

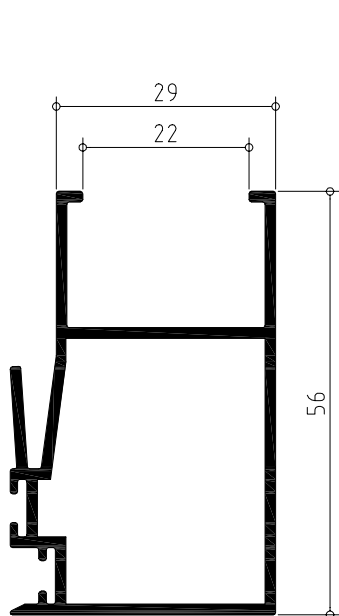

800260

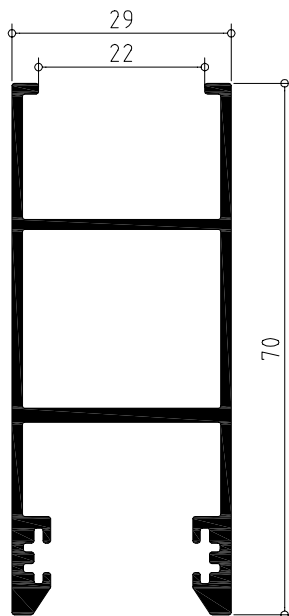

800320

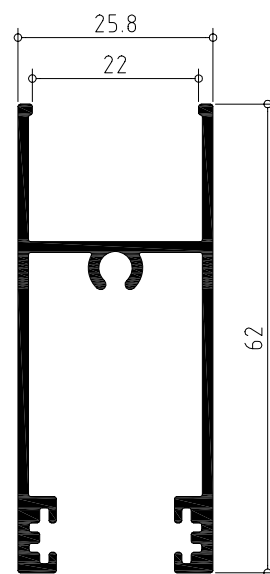

800360

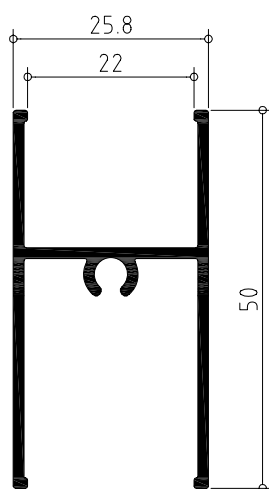

800911

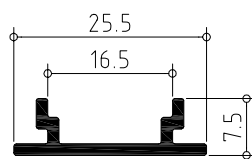

800762

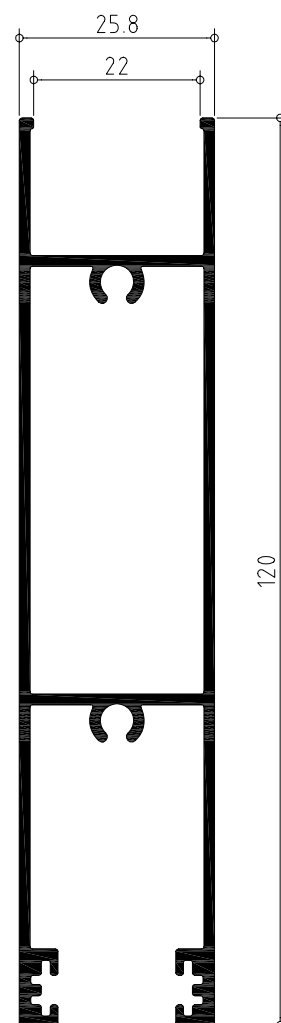

800902

Corredera serie 800

Hojas

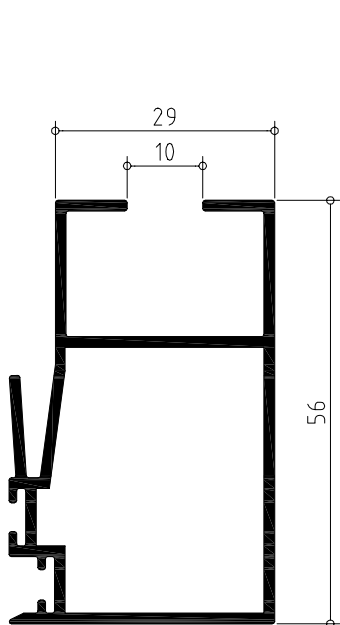

800255

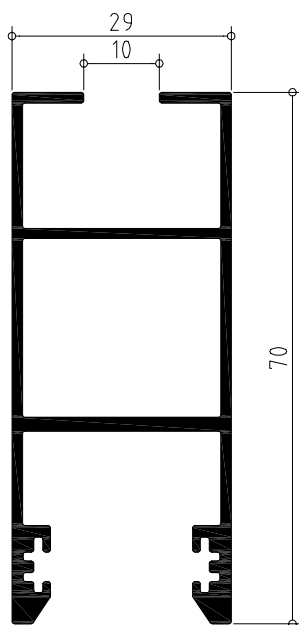

800315

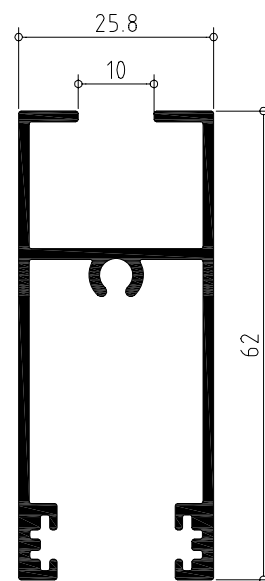

800350

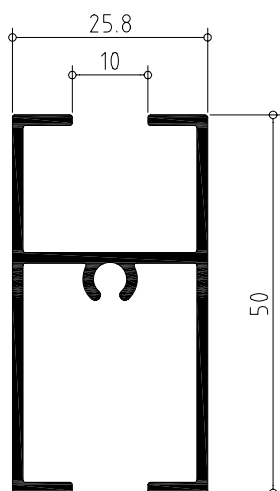

800910

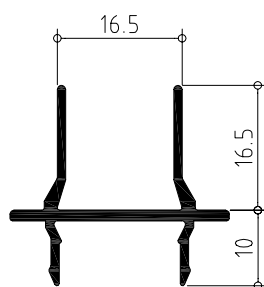

800761

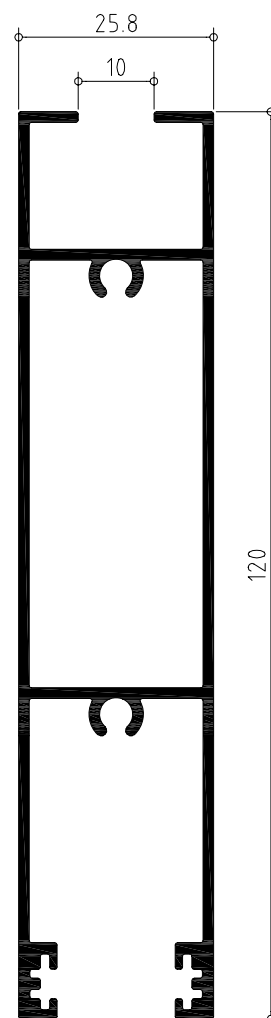

800900

Corredera serie 800

Marcos fijos y tapajuntas

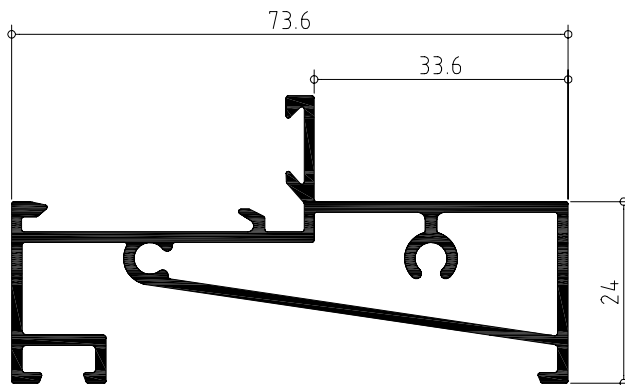

800627

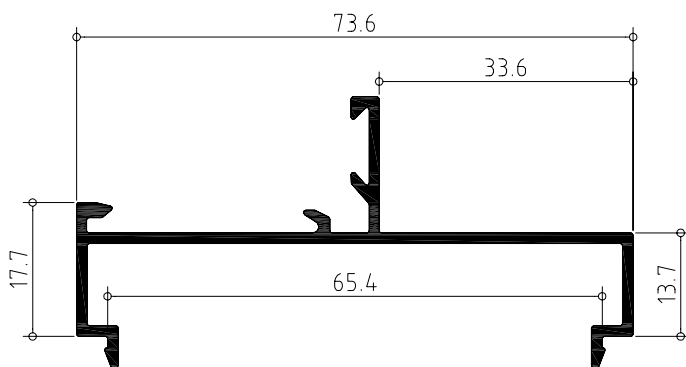

800625

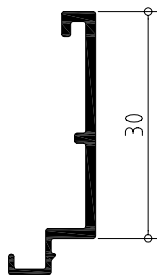

640809

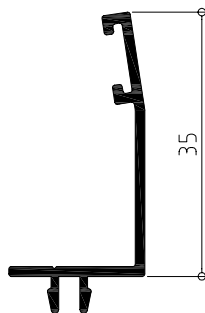

640804

Corredera serie 800

Marcos guia para compacto de 120

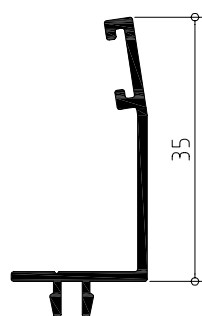
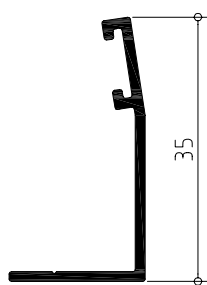
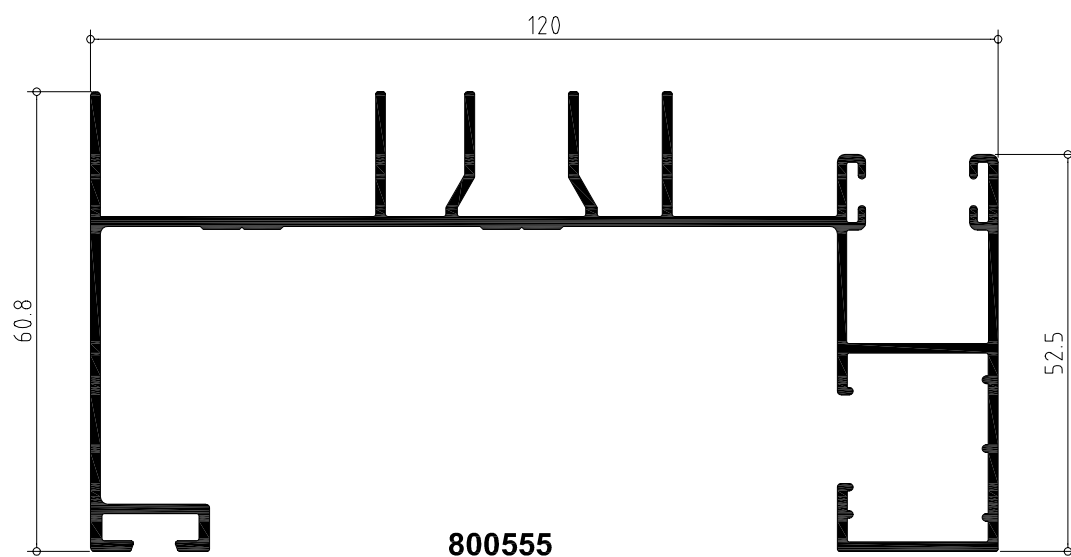
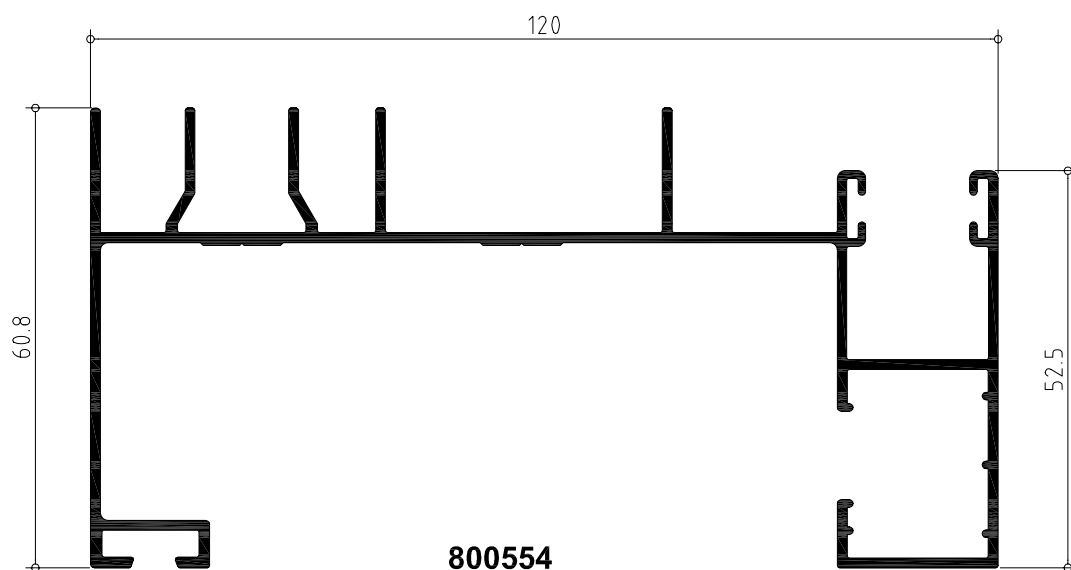

640805

640804

Corredera serie 800

Marcos guia para compacto de 132

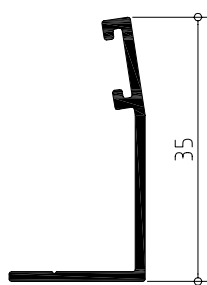
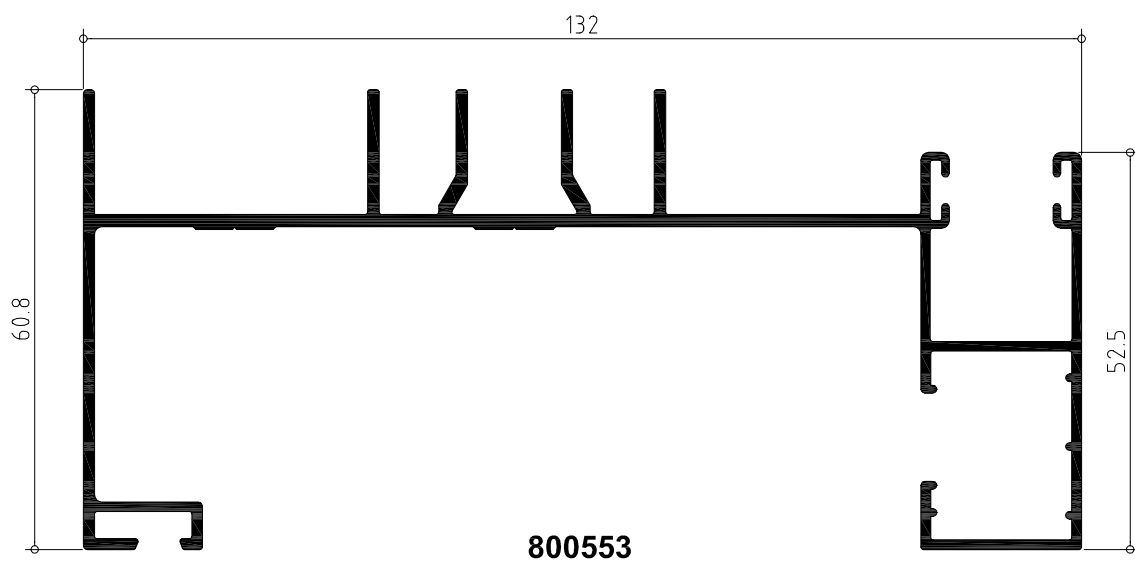
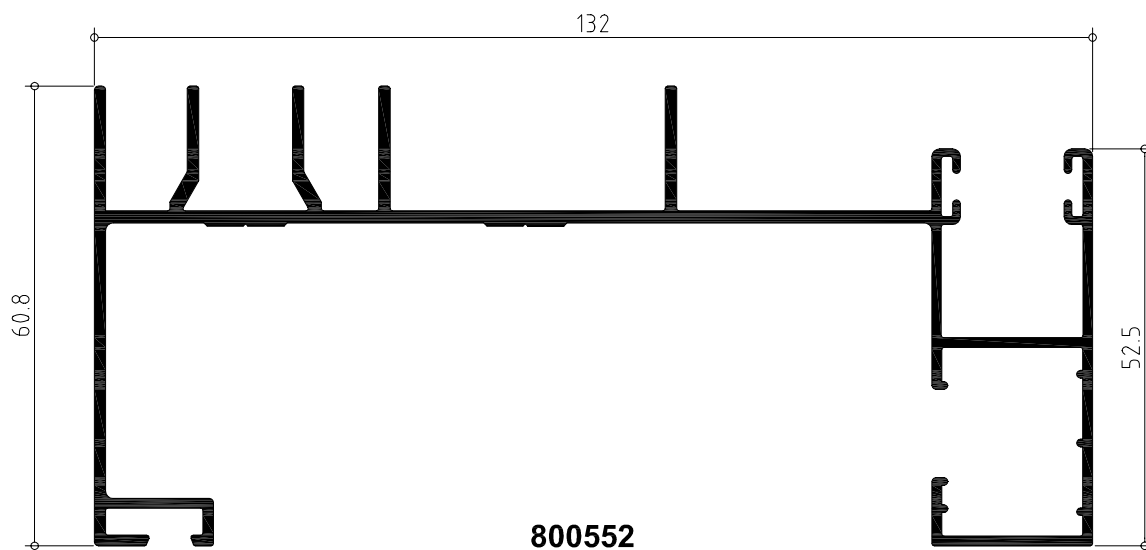

640805

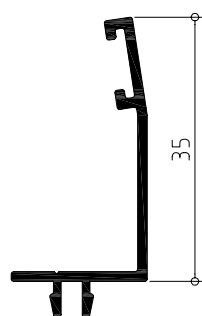

640804

Corredera serie 800

Marcos guia para compacto de 160

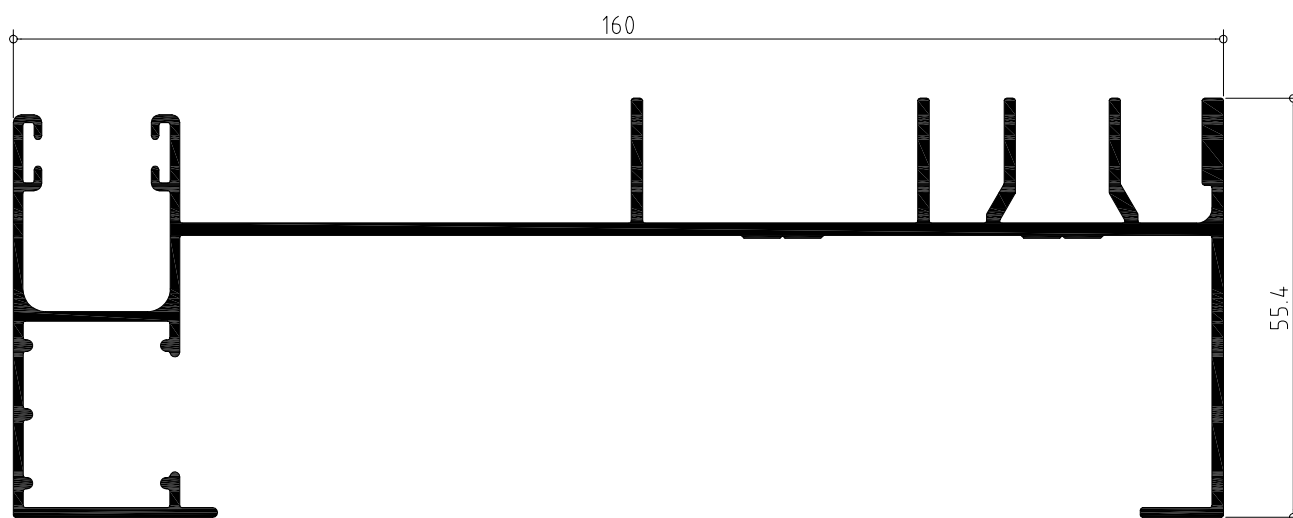

800550

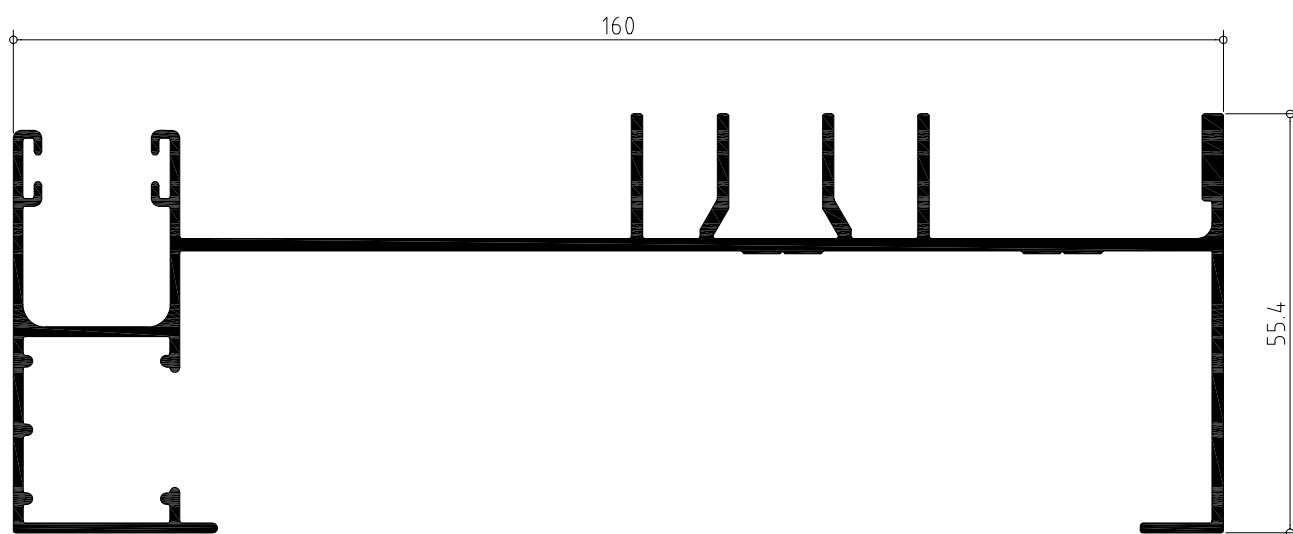

800551

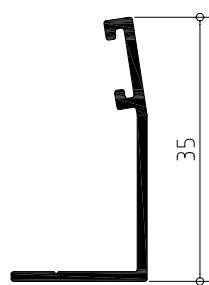

640805

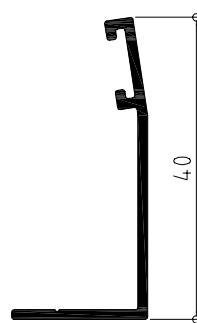

640814

Corredera serie 800

Marcos fijos monoliticos

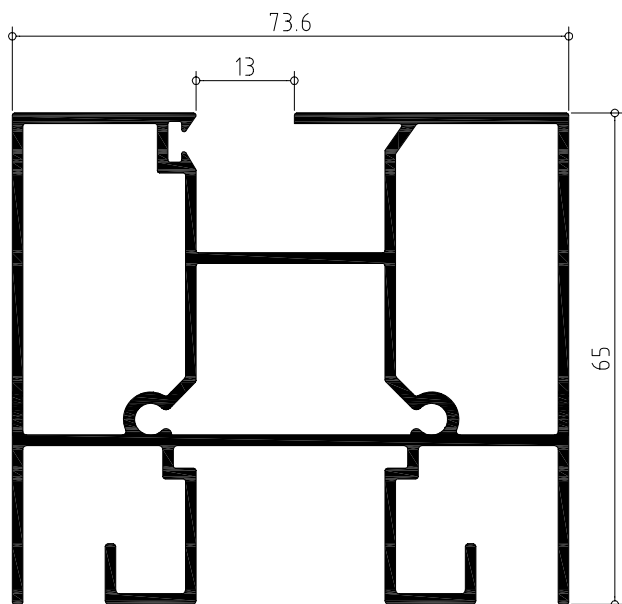

800228

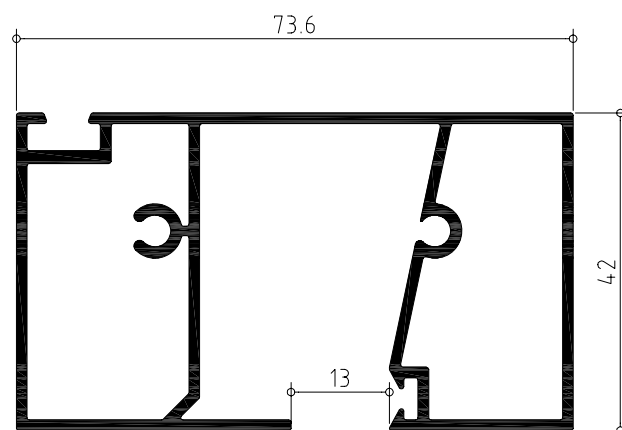

800631

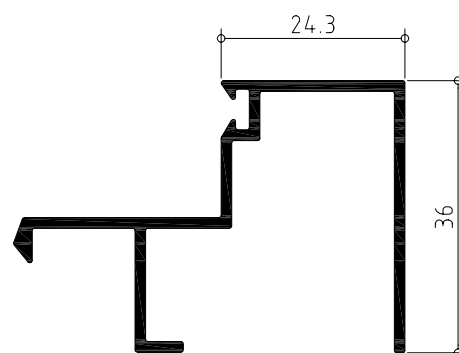

800717

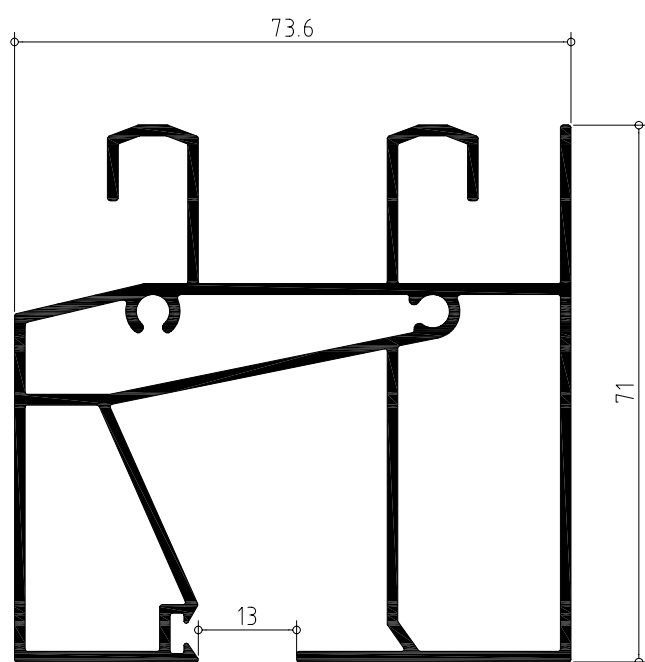

800199

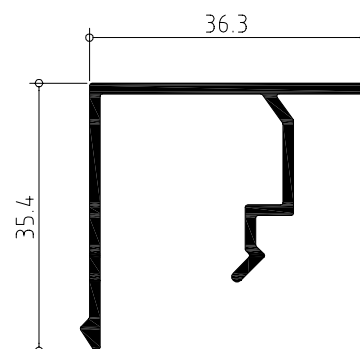

800718

Corredera serie 800

Marcos solape

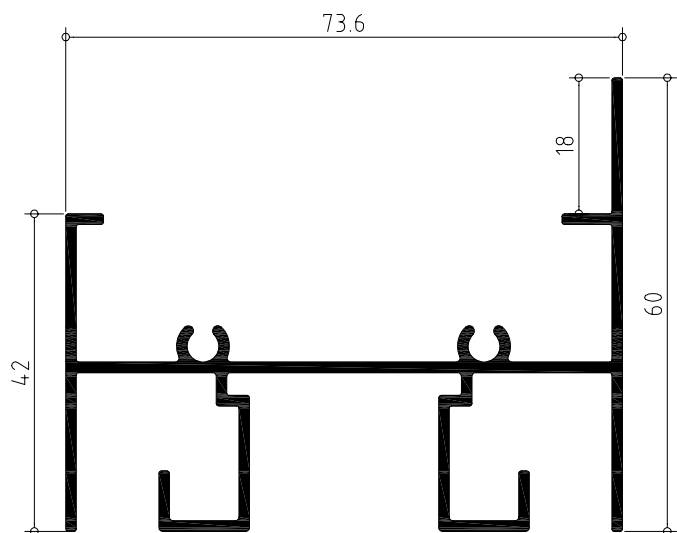

800230

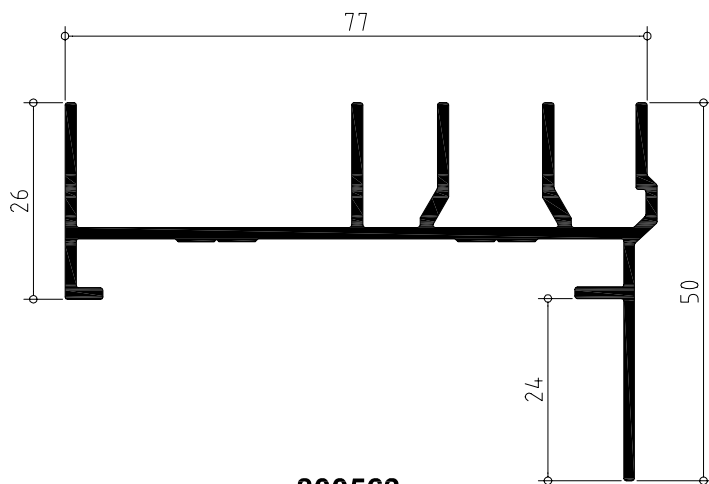

800563

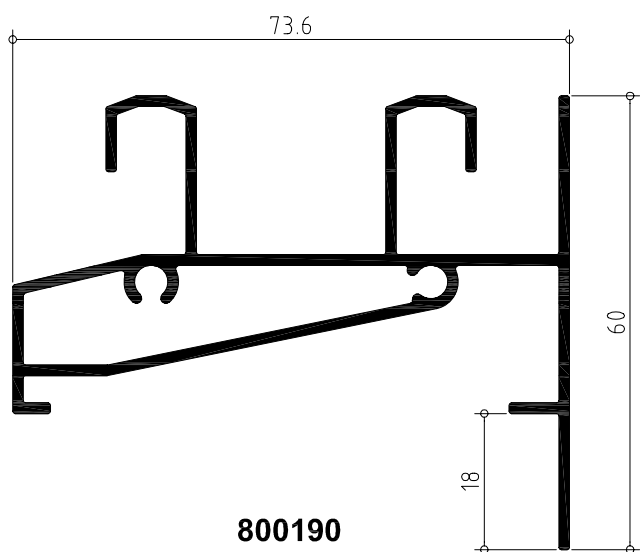

800190

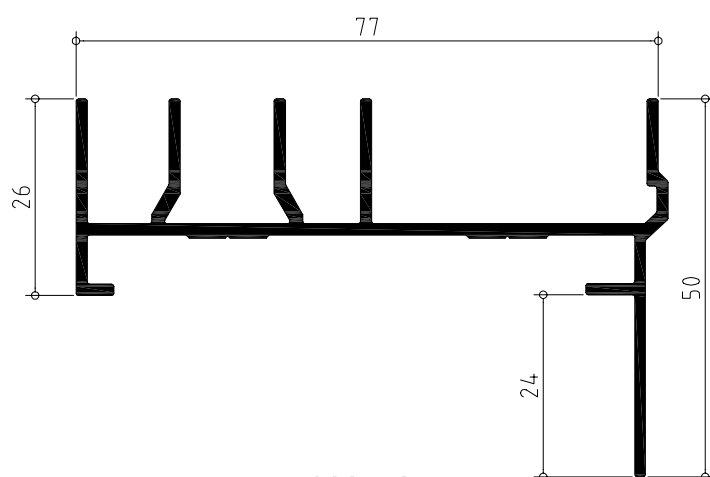

800573

Corredera serie 800

Marcos para tres hojas

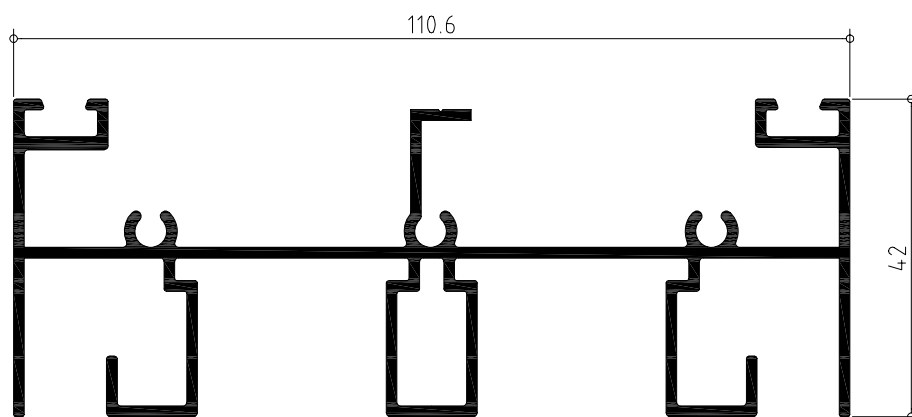

800235

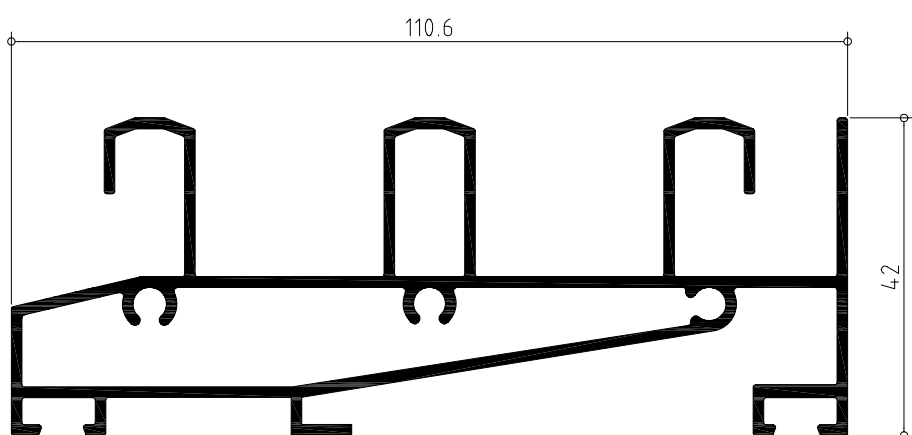

800195

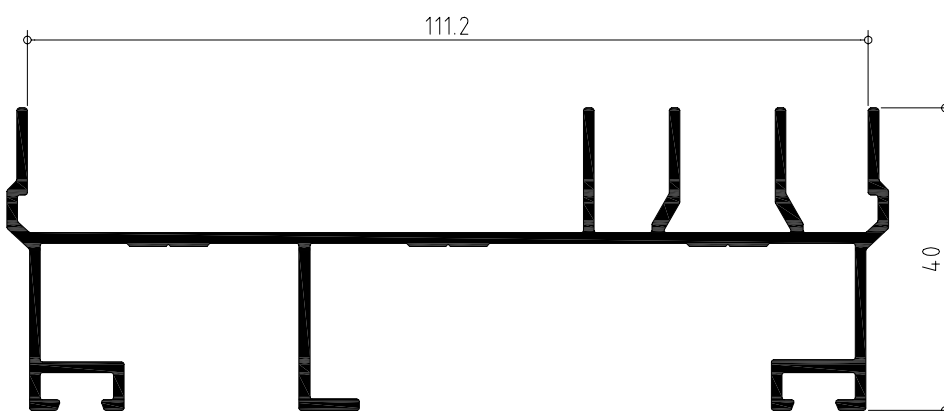

800540

Corredera serie 800

Marcos

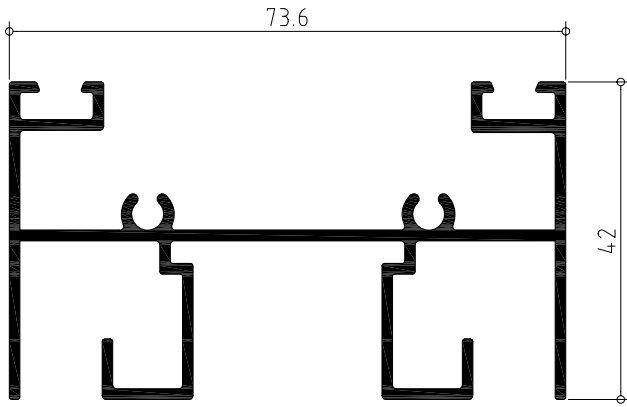

800225

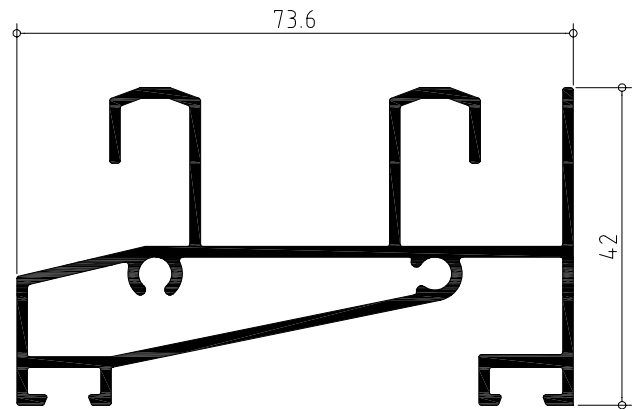

800186

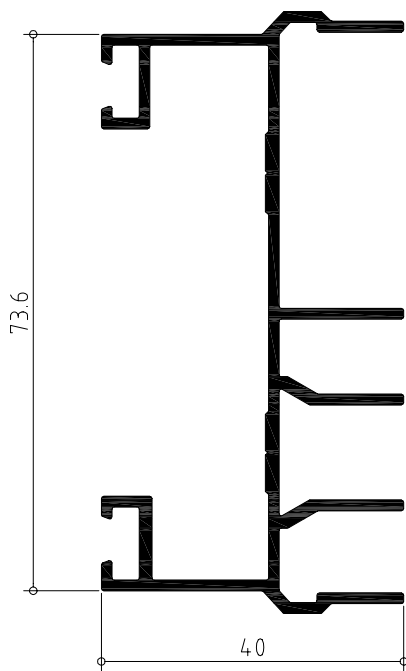

800530