



CATALOGO

MANUFACTURAS
ALDOMA, S.L.

INDICE

3

BISAGRAS

HINGES

6

CREMONASY MANILLAS

CREMONES BOLTS AND HANDLES

10

OSCILO-BATIENTE

TILT AND TURN MECHANISM

14

ESCUADRASY UNIONES

CORNER JOINTS AND T-UNIONS

17

PREMARCO

FRAMEWORK

19

ESCUADRA ALINEACIÓN

ALIGNMENT CORNERS

20

CIERRE MULTIPUNTO CORREDERAS

SLIDING ESPAGNOLETTE

22

CORREDERAS

SLIDING WINDOWS

24

BARANDILLAS

RAILING

25

VARIOS

SEVERALS

Ref. 429



Bisagra Camara Europea

Gliding Hinge for European Groove Profile

Ref. 433



Bisagra Camara Europea 3 Cuerpos

Three Pales Hinge for European Groove Profile

Ref. 430



Bisagra Camara Europea Pletina Inox

Gliding Hinge for European Groove Profile with Bridle in stainless steel

Ref. 442



Bisagra Camara Europea 3 Cuerpos Pletina Inox

Three Pales Hinge for European Groove Profile with Bridle in stainless steel

Ref. 439



Bisagra Puerta Camara Europea

Reinforced Hinge for European Groove Door

Ref. 428



Bisagra con Pletinas Camara Nacional (40x20)
Gliding Hinge for Spanish Groove Profile

Ref. 432



Bisagra con Pletinas Camara Nacional 3 Cuerpos
Three Pales Hinge for Spanish Groove Profile

Ref. 427



Bisagra Deslizante Camara Nacional (40x20)
Gliding Hinge for Spanish Groove Profile

Ref. 434



Bisagra con Pletinas Metales (4000)
Gliding Hinge for Special Spanish Groove

Ref. 440



Bisagra Embutida
Fixed Hinge To The Profile

Ref. 441



Bisagra con Pletinas Provedal
Gliding Hinge for Provedal Profile

Ref. 438



Bisagra Aluminios Canarias
Gliding Hinge for Canarian Profile

Ref. FS0311



Bisagra Proyectante
Friction Hinge for Projecting Style Windows

Modelo/ Model Medida/ Size	Valores máximos de ventana (Ancho x alto) <i>Maximum window width and height</i>	Valores máximos de ventana (Peso) <i>Maximum window weight</i>	Ángulo de apertura <i>Opening angle</i>
FS- 210	1200 X 300 mm	10 Kg	62 °
FS- 311	1200 X 600 mm	21 Kg	64°
FS- 515	1200 X 900 mm	24 Kg	42°
FS- 615	1200 X 1200 mm	32 Kg	38°

CREMONASY MANILLAS CREMONES BOLTS AND HANDLES

MANUFACTURAS

ALDOMA, S.L.



Ref. 0408-E



Cremona Aco Europea
Aco Europea Cremona Handle

Ref. 0408-H



Cremona Huella
Huella Cremona Handle

Ref. 0400



Cremona Mágnum
Mágnum Cremona Handle

Ref. 0426



Cremona Aco Oscilo
Aco Cremona for Tilt and Turn Mecanism



Ref. 0408-EXT



Cremona Aco Eur. Puño Extraible
Aco Europea Cremona with Removable Fist

Ref. 0419



Cremona Aco
Aco Cremona Handle

Ref. 0404

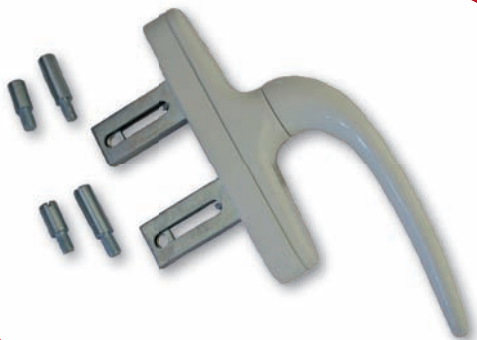

Cremona Apertura Exterior
Cremona Handle for Outside Opening

Ref. 0416-REG



Pasador 2° Hoja Camara Europea Cerradero Regulable
Lathe set with Adaptable Receiving Elements for Paired Wings

Ref. 0415



Kit Cremona Camara Europea
Locking Kit for One Wing

Ref. 0416



Pasador 2° Hoja Camara Europea
Lathe set with Receiving Elements for Paired Wings

Ref. 0423



Cierre Presion
Pressure Locker for Hinge Systems

Ref. 0413-E



Golpete Camara Europea
Safety Catch for European Groove

Ref. 0413-REG



Golpete Europeo Regulable
Adaptable Safety Catch for European Groove

Ref. 0421 I / 0422 I



Compas Inox Camara Europea
Alt Stop in Stainless Steel for European Groove

Ref. 0407



Pasador 2° Hoja Camara Europea Zamak
Zamak Latche Set for Paired Wings

Ref. 0405



Kit Cremona 4000-6000
Locking Kit for One Wing for Spanish Groove

Ref. 0417



Manilla Aco
Aco Double Handle

Ref. 0417-ESC



Manilla con Escudo
Double Handle with Scutcheon

Ref. 0420



Manilla Escudo Giratorio
Double Handle with Rotating Front

OSCILO-BATIENTE TILT AND TURN MECHANISM

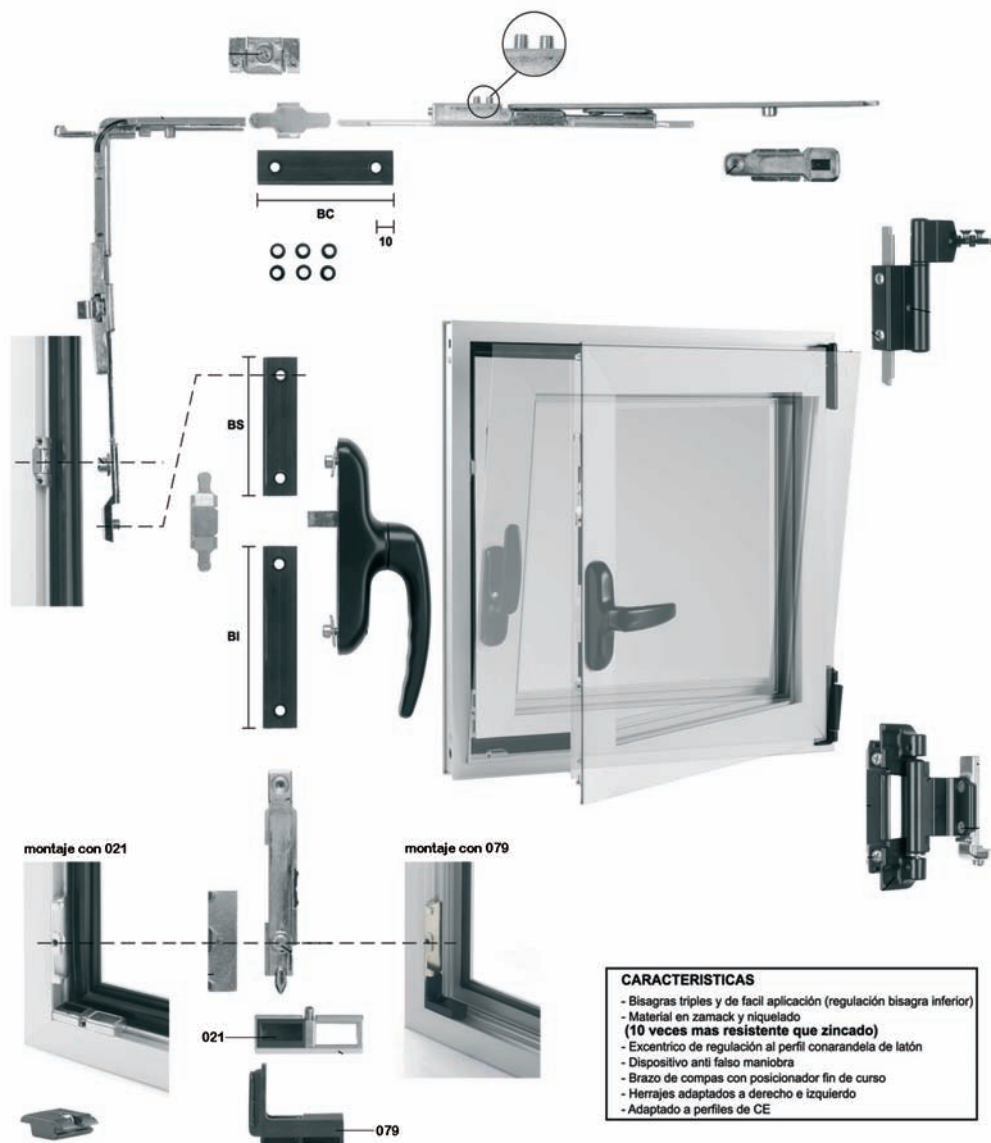

CARACTERISTICAS

- Bisagras triples y de facil aplicación (regulación bisagra inferior)
- Material en zamack y niquelado
(10 veces mas resistente que zincado)
- Excentrico de regulación al perfil conarandela de latón
- Dispositivo anti falso maniobra
- Brazo de compas con posicionador fin de curso
- Herrajes adaptados a derecho e izquierdo
- Adaptado a perfiles de CE



MANUFACTURAS

ALDOMA, S.L.

OSCILO-BATIENTE
TILT AND TURN MECHANISM

KIT REENVIO



COMPAS SUPLEMENTARIO



TABLA DE DESCUENTOS COMPAS

MODELO	LARGO MIN. HOJA	LARGO MÁX. HOJA	CORTE DE LAS BARRAS DISTANCIA AL CENTRO d=10mm
COMPAS 300	375	495	PC = LF - 162
COMPAS 400	495	585	BC = LF - 401
COMPAS 500	585	1300	BC = LF - 507

TABLA DE DESCUENTOS PLETINA VERTICAL

BARRA SUP.			BS = H2 - 229
BARRA INF.			BI = H1 - 155

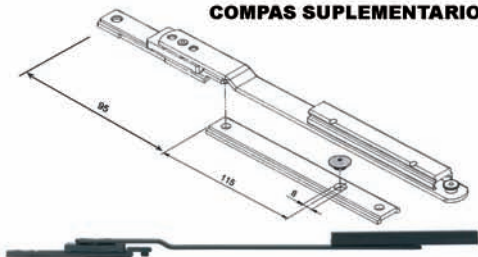

KIT 2ª HOJA

Oscilo-Batiente con Cierre al Marco
Tilt and Turn Mechanism with Closing in the Frame

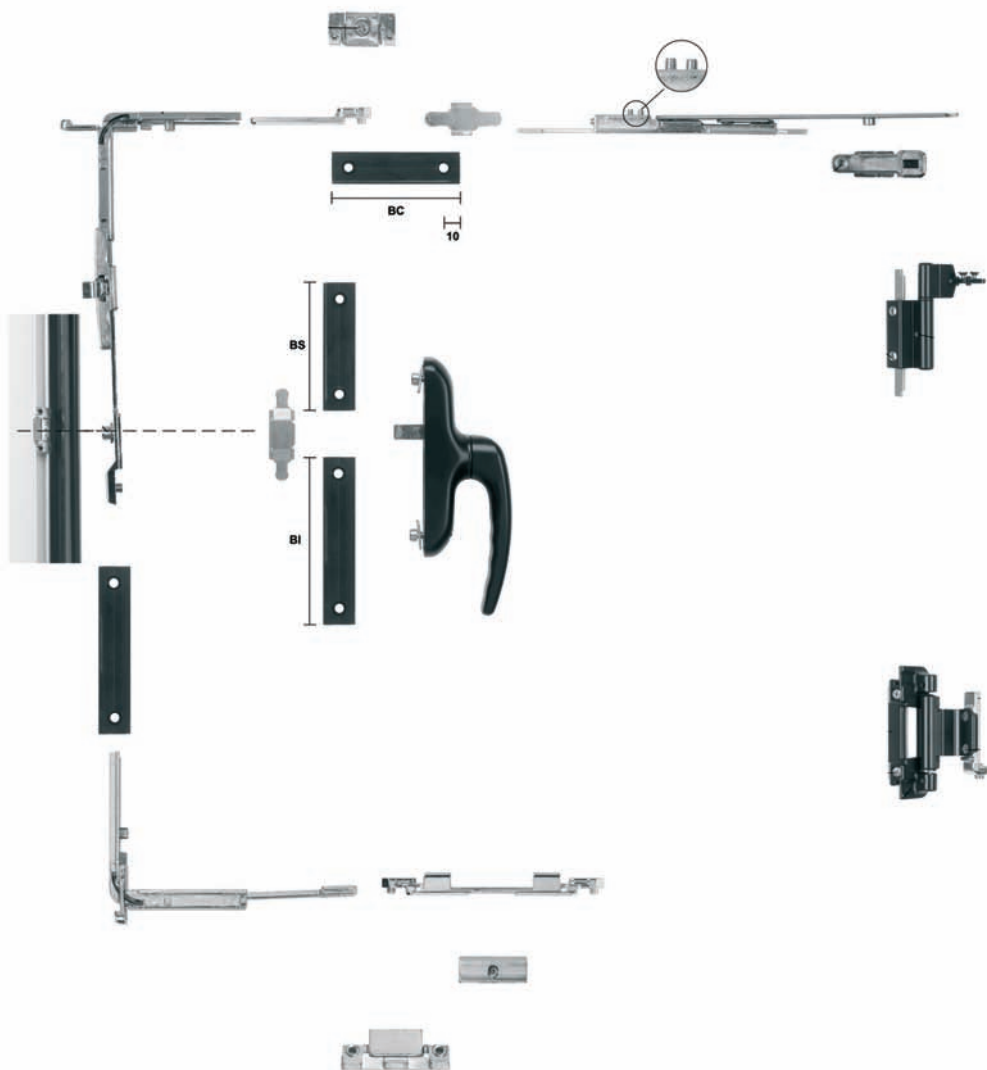



MANUFACTURAS

ALDOMA, S.L.

OSCILO-BATIENTE
TILT AND TURN MECHANISM



TABLA DE DESCUENTOS COMPAS

MODELO	LARGO MIN. HOJA	LARGO MÁX. HOJA	CORTE DE LAS BARRAS DISTANCIA AL CENTRO d=10mm
COMPAS 300	375	495	PC = LF - 162 (SIN 070)
COMPAS 400	495	585	BC = LF - 463 (CON 070)
COMPAS 500	585	1300	BC = LF - 569 (CON 070)

TABLA DE DESCUENTOS PLETINA VERTICAL

BARRA SUP.			BS = H2 - 229
BARRA INF.			BI = H1 - 145

Ref. RDA...

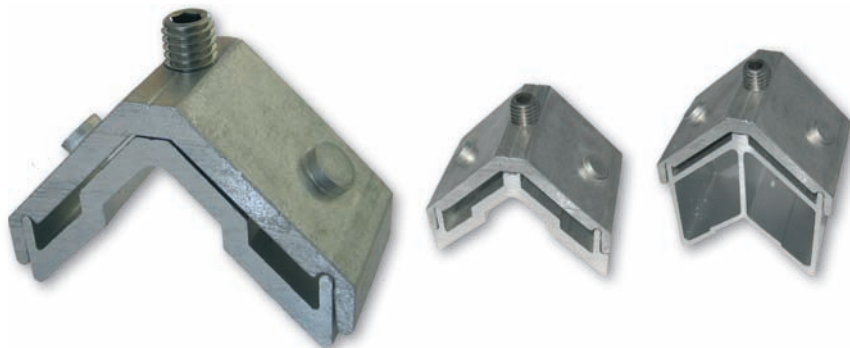

Escuadra Bloqueo Teton Redondo
Aluminium Expansion Corner Joint (Rounded Button)

Ref. RA...

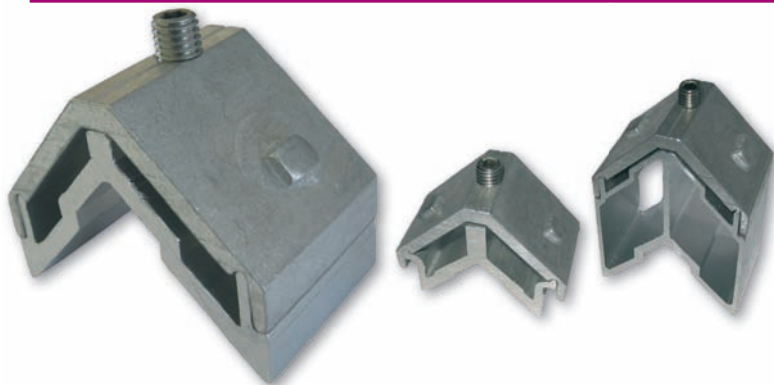

Escuadra Bloqueo Teton Rectangular
Aluminium Expansion Corner Joint (Square Button)

Ref. RD6...



Escuadra Bloqueo Teton Redondo diámetro 6
Aluminium Expansion Corner Joint (Rounded Button of 6mm Diameter)

Ref. E...



Escuadra Europea
Aluminium European Corner Joint

Ref. ETL...



Escuadra Europea Tiro Largo
Long Press Aluminium European Corner Joint

Ref. SA...



Escuadra Tiro Largo
Long Press Aluminium Corner Joint

Ref. M...



Escuadra Teton Muelle
Soft Aluminium Corner Joint

Ref. TB...

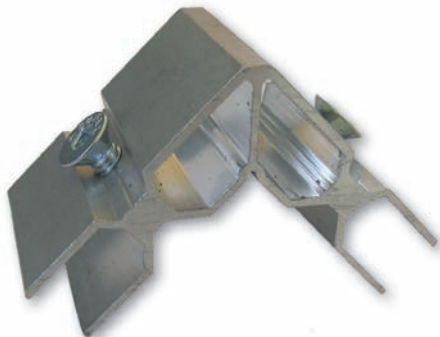

Escuadra Tubular
Tubular Aluminium Corner Joint

Ref. TBR...

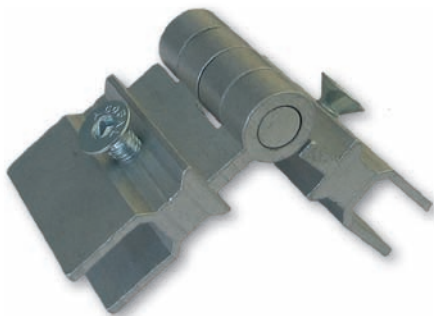

Escuadra Tubular Regulable
Adaptable Tubular Aluminium Corner Joint

Ref. ES...



Escuadra Espina - Bala
Shoot Aluminium Corner Joint

Ref. 8...



Unión Europea Guiada
Guided T-Union for European Groove

Ref. 6...



Unión Europea Abierta
Opened T-Union for European Groove

Ref. 5...

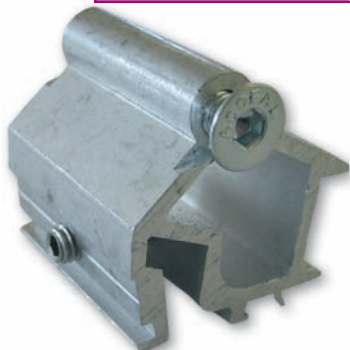

Unión Camara Nacional (40x20)
Opened T-Union for Spanish Groove

Conjunto Premarco



Conjunto Premarco

Ref. PRI60x18



Refuerzo Premarco
Sterngthen in Steel for Framework

Ref. PNI60x18

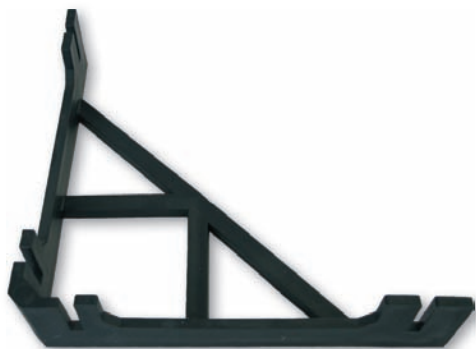

Cartabón Nylon
Sterngthen in Nylon for Framework

Ref. PRE-FIJA



Refuerzo Fijo
Non Retornable Sterngthen in Steel for Framework

Ref. P24x16



Escuadra Premarco Nylon Estrecha
Narrow Framework Nylon Angle

Ref. P37x16



Escuadra Premarco Nylon Ancha
Wide Framework Nylon Angle

Ref. 0560-1



Garra de Anclaje Guiada
Anchorage of Frames Guided

Ref. PA...



Escuadra Premarco Aluminio
Framework Aluminium Angle

Ref. 0560



Garra de Anclaje
Anchorage of Frames



MANUFACTURAS

ALDOMA, S.L.

ESCUADRA ALINEACIÓN
ALIGNMENT CORNERS

ESCUADRA ALINEACIÓN
ALIGNMENT CORNERS

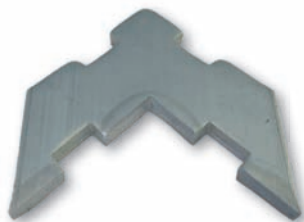
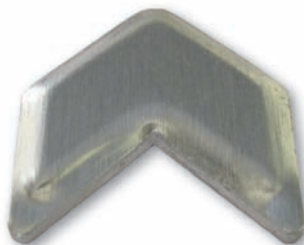

Ref. CM75



Multipunto Aguja 7,5 mm.
7.5 Axis Espagnolette

Ref. CM15



Multipunto Aguja 15 mm.
15 Axis Espagnolette

Ref. CM25 CERR...



Multipunto con Cerradura
Lockable Espagnolette

Ref. CERR-MARCO



Cerradero Marco
Striker

Ref. SEGURO-ANTI



Seguro Antielevación
Centering Zamak

Ref. 0417-MA



Manilla Multipunto Aluminio-Plastico
Aluminium-Nylon Sliding Window Handle

Ref. 0460



Manilla Multipunto "Elite" Zamak
"Elite" Zamak Sliding Window Handle

Ref. 0461



Manilla Multipunto Embutida
Sliding Hidden Window Handle

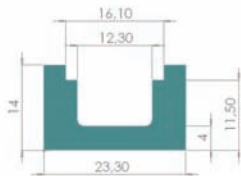

CALZO DISTANCIADOR 1

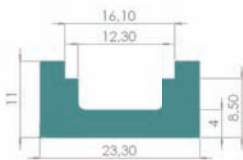

CALZO DISTANCIADOR 2

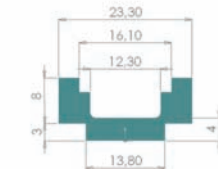

CALZO DISTANCIADOR 3

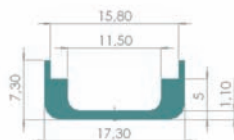

CALZO DISTANCIADOR 4

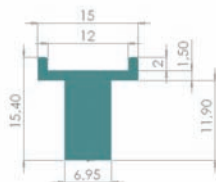

CALZO MARCO
Corte Recto

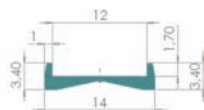

CALZO MARCO
Perimetral

Ref. 0403



Cierre de Nylon
Nylon Lateral Closing Gear

Ref. 0391



Cierre Zamak Estrecho
Zamak Lateral Closing Gear

Ref. 0397



Cierre sin tornillos
Aluminium Lateral Closing without Screws

Ref. 0398



Cierre sin tornillos ancho
Wide Aluminium Lateral Closing without Screws

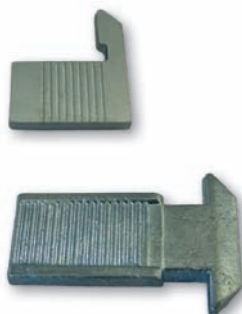

Uñas de cierre
Nails



Contracierres de Marco
Frame Hooks

Ref. 0418



Asa Tirador
Pull Handle for Lateral Closing Gear



Kits para Correderas
Kits for Sliding Windows

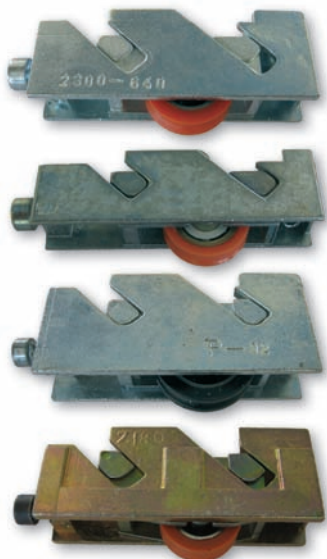

Ruedas Regulables Zamak
Zamak Adjustable Rollers for Sliding Windows



Ruedas Nylon
Nylon Rollers for Sliding Windows

Ref. 659



Pie Barandilla 40x20 Desplazado
Off-centre Railing Base 40x20

Ref. 657



Pie Barandilla 40x20
Railing Base 40x20

Ref. 658



Pie Bandilla 40x40
Railing Base 40x40

Ref. 652



Pie Barandilla 30x30 40x40
Railing Base 30x30 40x40

Ref. 650



Pie Barandilla 30x30
Railing Base 30x30

Ref. 655



Tapa Pasamano
Handrail Cap

Ref. 0468...



Grapas Junquillo Curvo
Clips Several Models

Ref. JPMI135



Soporte Lama Fija
Nylon Support for Slats

Ref. 2NI058



Salida de Aguas
Plugs of Drainage



Calzo Acrístar
Wedges for Glass

Ref. 0575



Escuadra Mosquitera
Mosquito Net Corner Joint

Ref. 0576



Tensor División Oficinas
Tunion for Office Separation

Ref. C001...



Cerradura con frente en Inox
Mono Point Lock

Ref. CERR-I



Cerradero Regulable Inox
Stainless Steel Striker Plate

Ref. C000...



Cerradura 3 Puntos
Three Points Lock

Detalle cerradura
Lock Details

Ref. 0574-SEG



Escudo Cerradura Seguridad
Safety Lock Shield

Ref. 574



Escudo Cerradura
Lock Shield

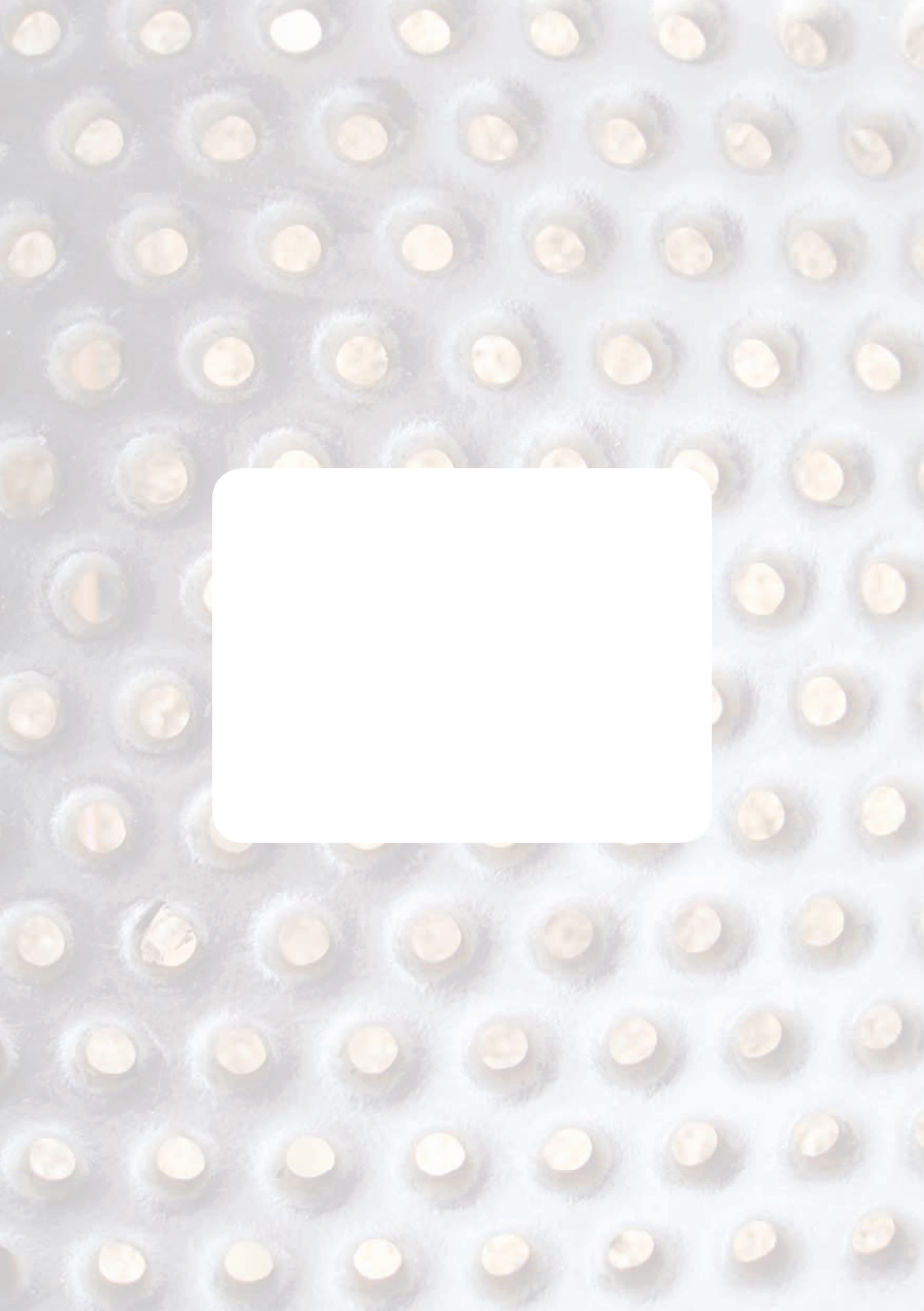



MANUFACTURAS
ALDOMA, S.L.

MANUFACTURAS ALDOMA S.L.

OFICINAS: Polígono Industrial Morea Sur, 52
31191 BERIAIN (NAVARRA) - ESPAÑA
Tel.: +34 948 310 735 - Fax: +34 948 310 090
E-mail: aldoma@arrakis.es

FÁBRICA / EXPORT DEPARTMENT

Polígono Industrial La Dehesa, s/n.
42200 ALMAZÁN (SORIA) - ESPAÑA
Tel.: +34 975 301 012 - Fax: +34 975 301 036
E-mail: aldomaalmazan@arrakis.es

www.aldoma.eu
www.aldoma.com