

# Abisagrada CE CM-53RT

## Secciones nudos

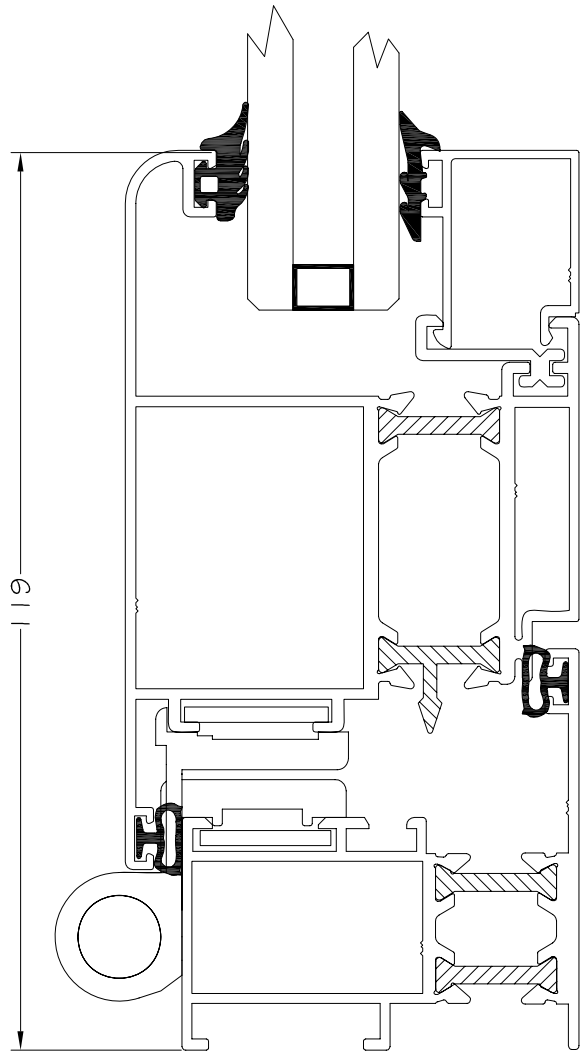
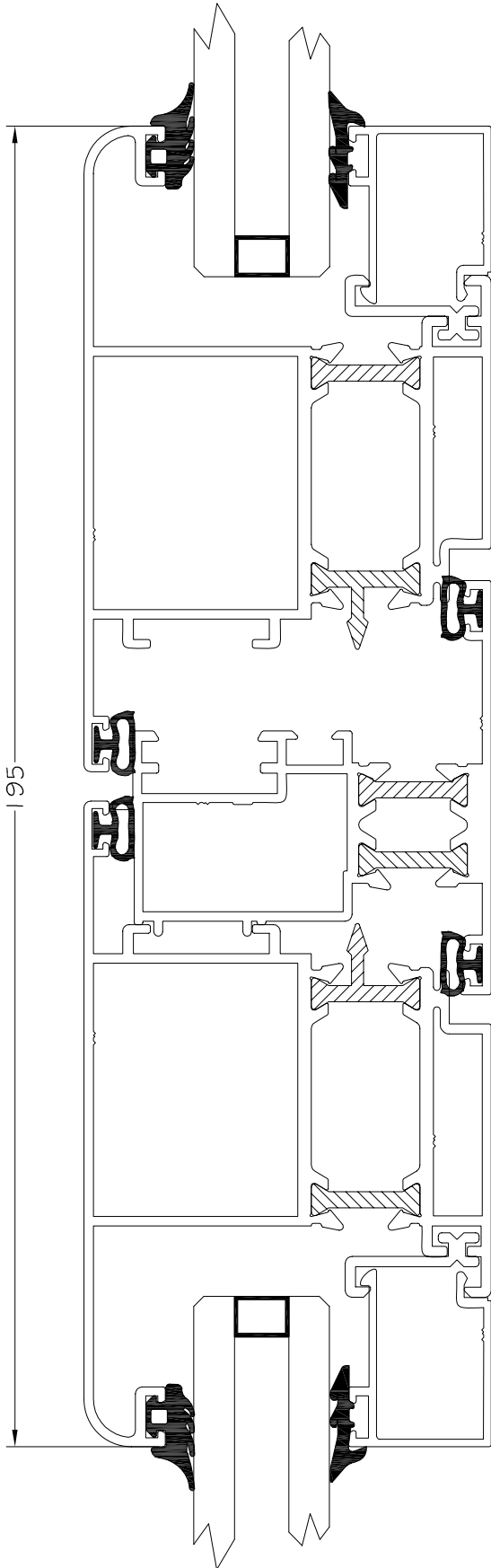

# Abisagrada CE CM-53RT

## Secciones nudos

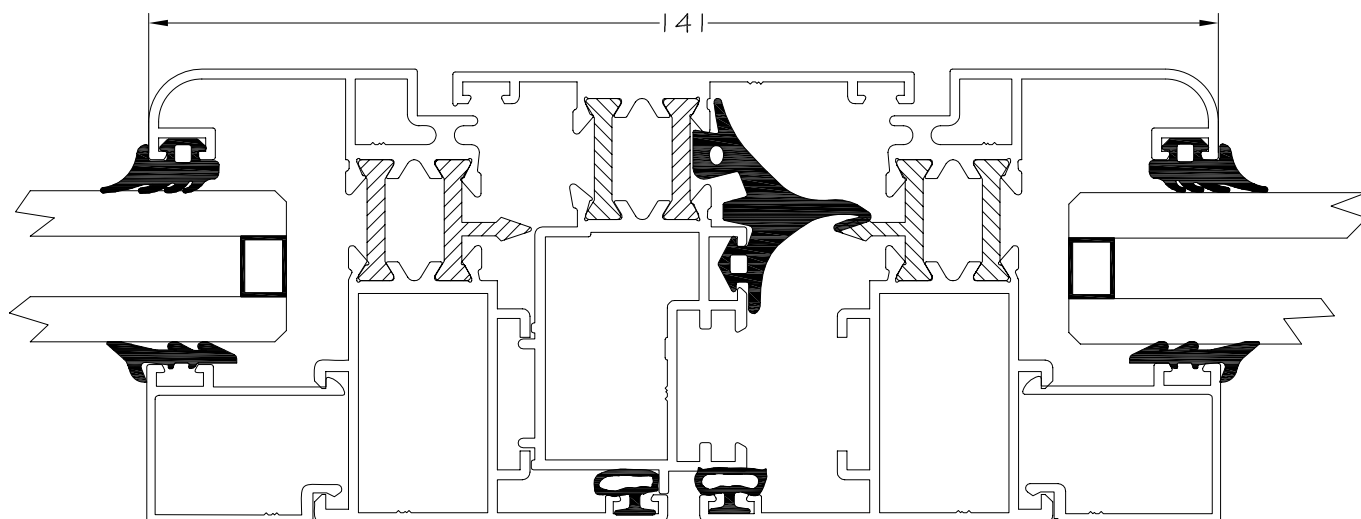
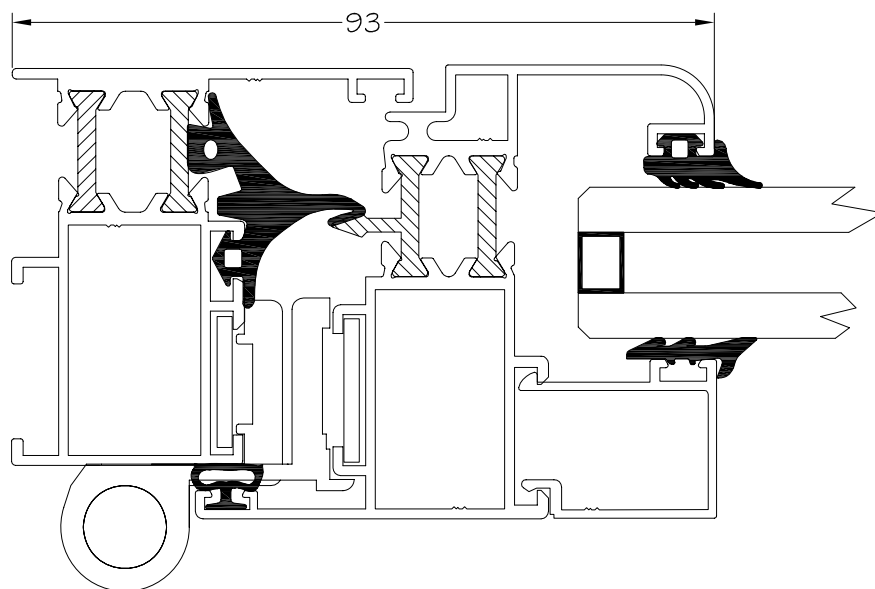

# Abisagrada CE CM-53RT

## Secciones nudos

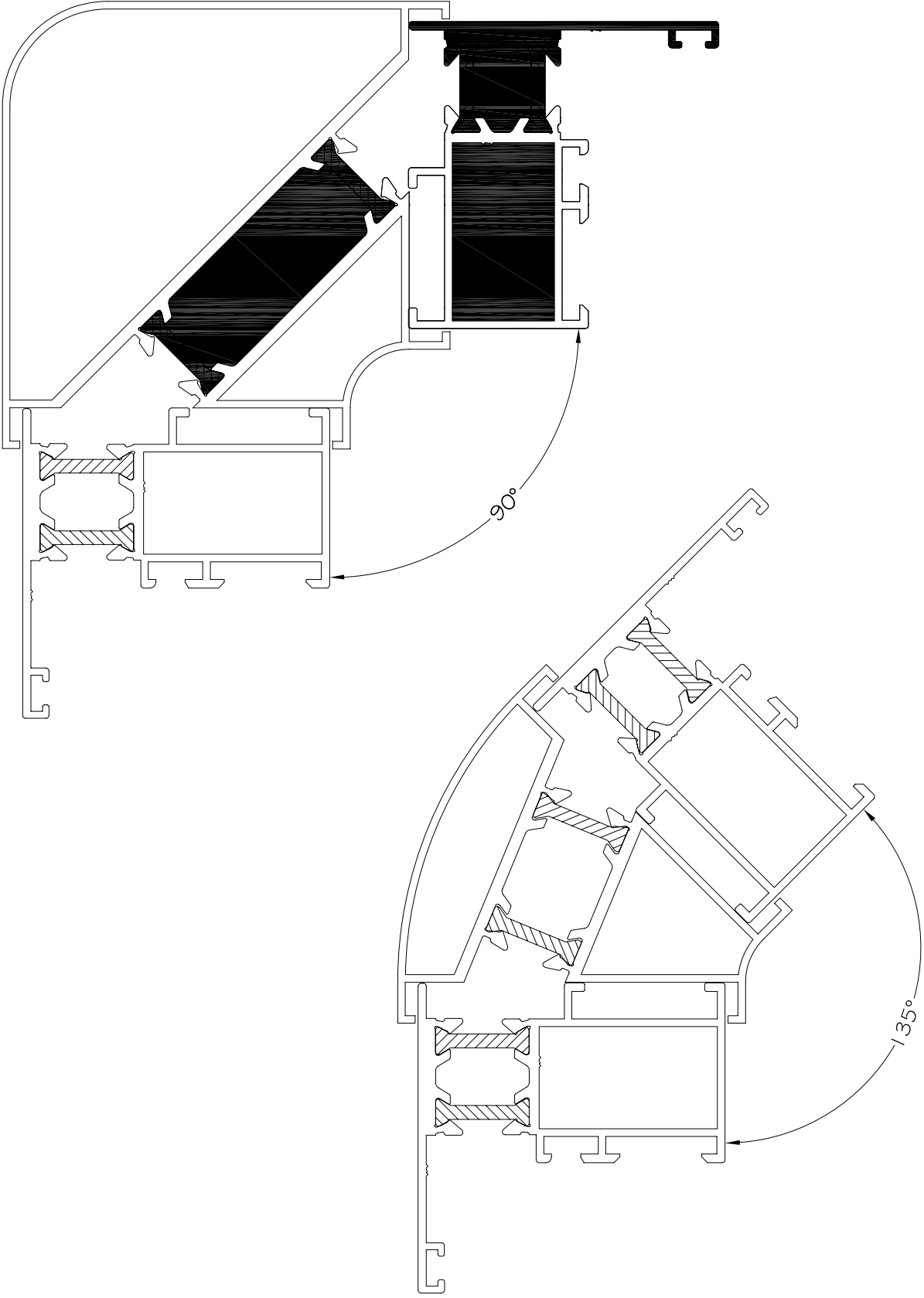

# Abisagrada CE CM-53RT

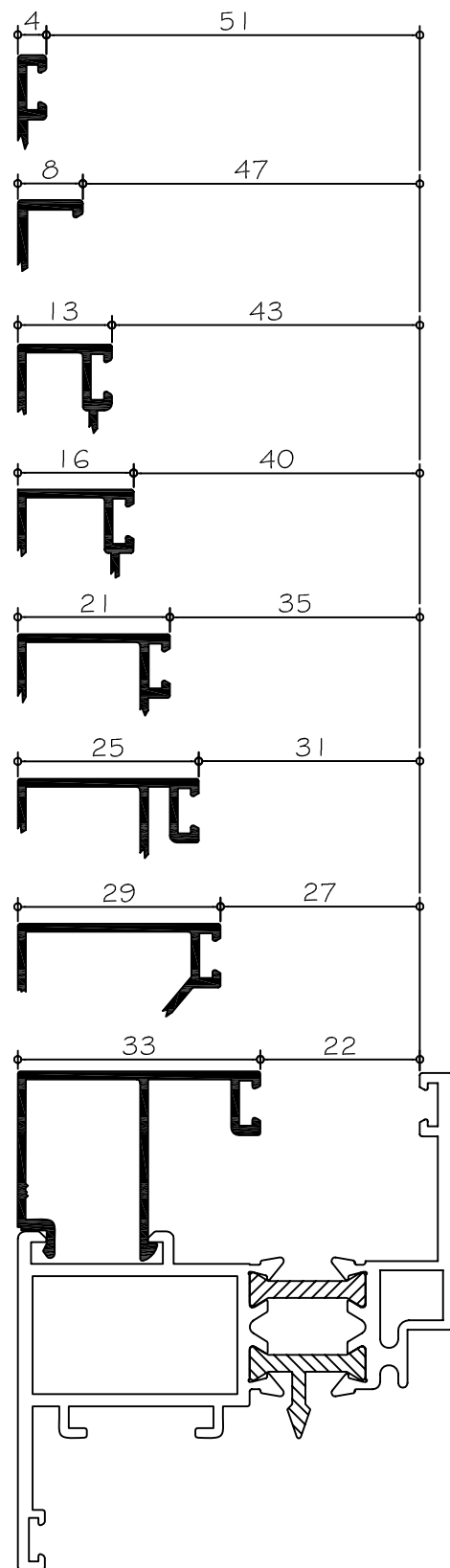
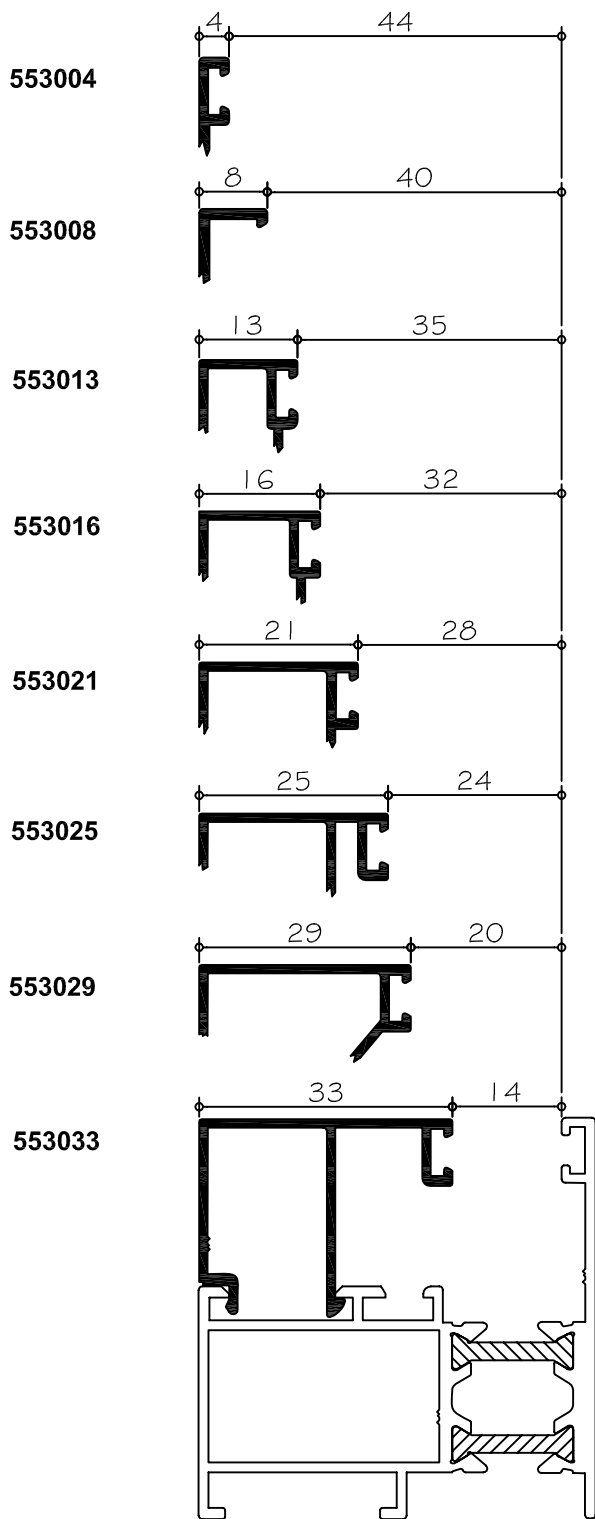

TAMBIEN VALIDOS PARA  
HOJAS DE 60 CURVAS

# Abisagrada CE CM-53RT

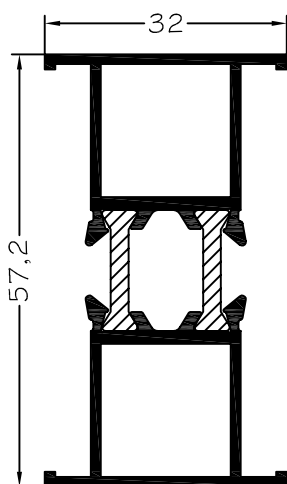

553745

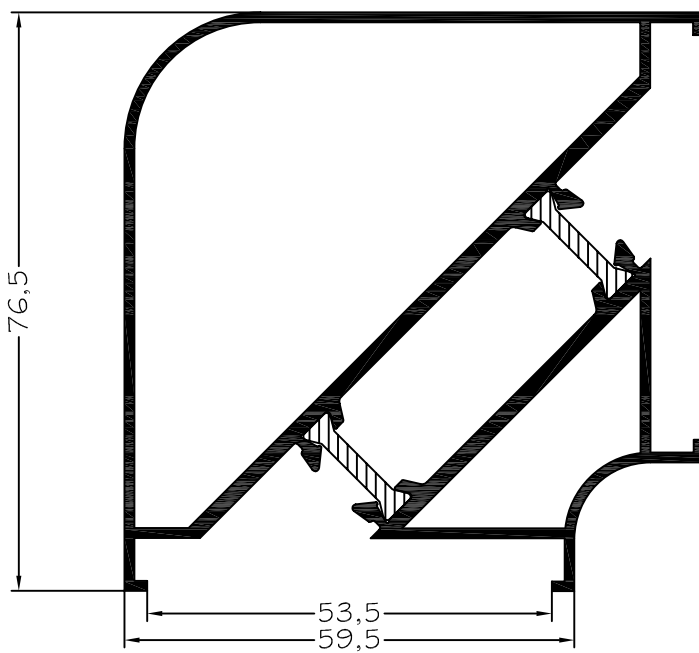

553161

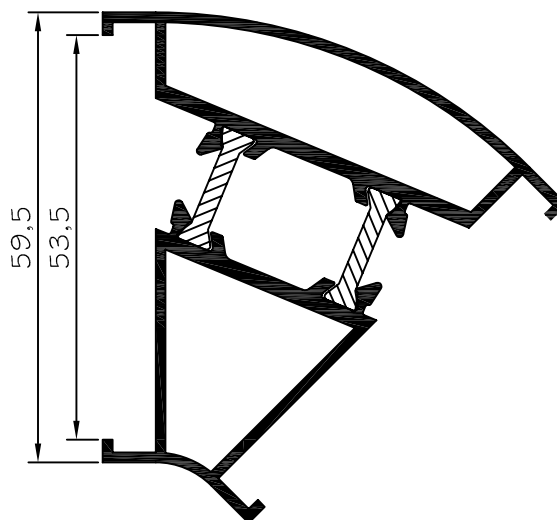









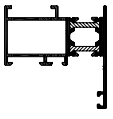



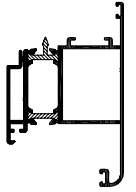

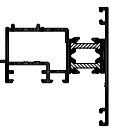

553180

# Abisagrada C.E. Serie CM-53RT CAP

Secciones y hoja de corte

Ventana de dos hojas practicables, a marco cerrado, apertura exterior

PERFIL	CODIGO	POSICION	UNIDADES	CORTE	MEDIDA
	553144	Horizontal	2		= L
		Vertical	2		= H
		Horizontal	4		L/2 - 41,5 mm.
	553358	Vertical	4		H - 78 mm.
	553504	Vertical	1		H - 142
	850022	Vertical	1		Segun modelo cremona y sus accesorios
		Horizontal	4		A - 127,5 mm.
	553763	Vertical	4		B - 127,5 mm.
		Horizontal	4		A - 146 mm.
	553021	Vertical	4		B - 190 mm.

## Accesorios



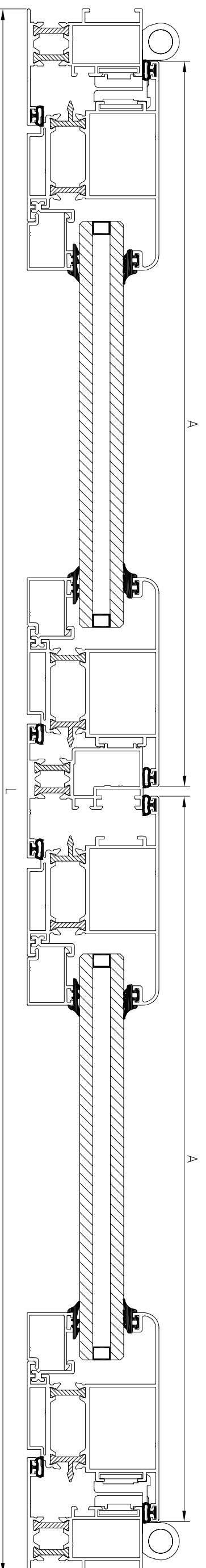
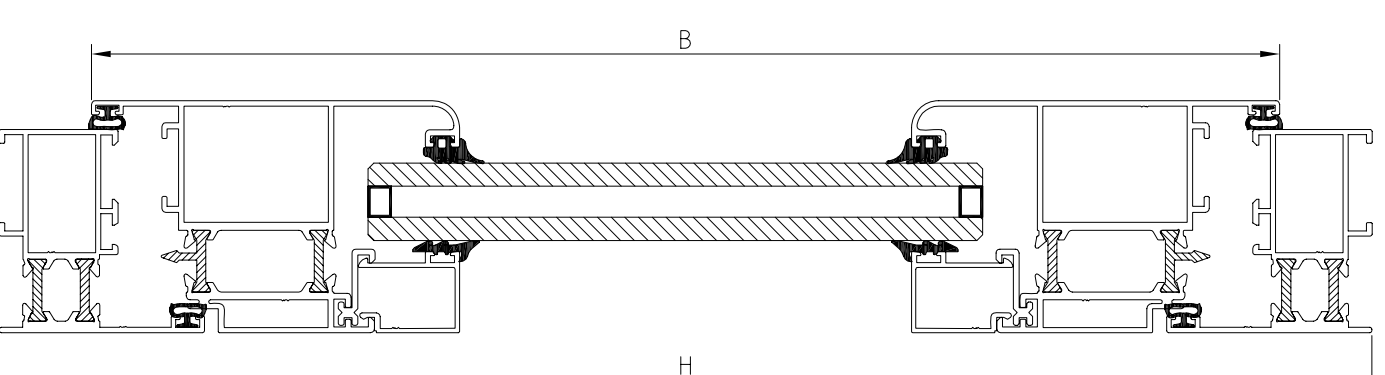







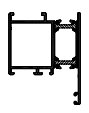

UNIDADES	DESCRIPCION
4	Bisagra cámara Europea
4	Escuadra marco ventana
8	Escuadra hoja puerta
12	Escuadra alineamiento
1	Cremona para Falleba
1	Kits cremona una hoja para cámara Europea
1	Kits pasadores segunda hoja para cámara Europea
1	Juego tapas inversor
2	Defector salida agua
4L + 8H	Junta batiente

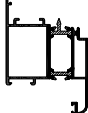

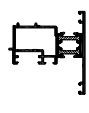
# Abisagrada C.E. Serie CM-53RT CAP

Secciones y hoja de corte

Puerta de dos hojas practicables, a marco cerrado

PERFIL	CODIGO	POSICION	UNIDADES	CORTE	MEDIDA
	553144	Horizontal	2		= L
		Vertical	2		= H
		Horizontal	4		L/2 - 41,5 mm.
	553341	Vertical	4		H - 78 mm.
	553504	Vertical	1		H - 142
	850022	Vertical	1		Segun modelo cremona y sus accesorios
		Horizontal	4		A - 134 mm.
		Vertical	4		B - 178 mm.

ACCESORIOS



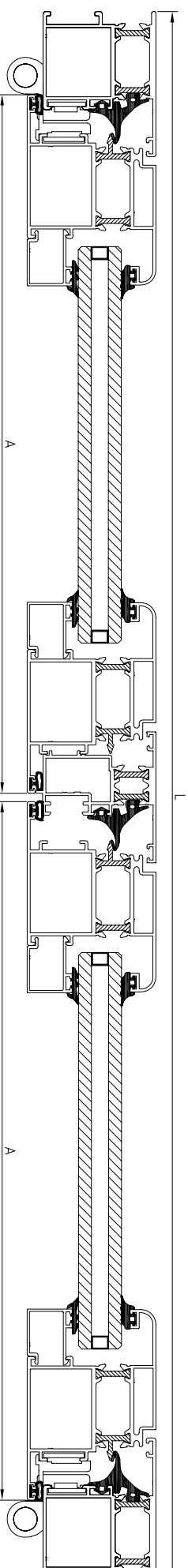
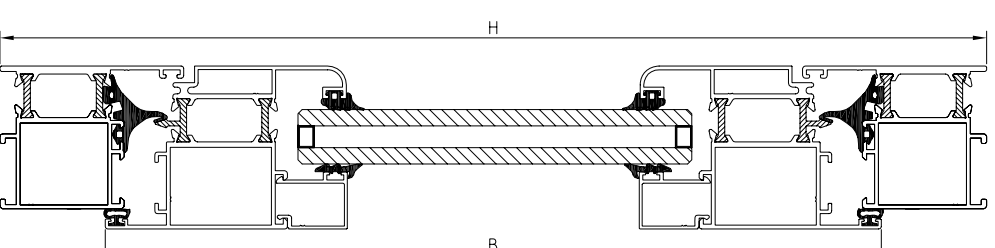





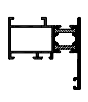

UNIDADES	DESCRIPCION
6	Bisagra cámara Europea
4	Escuadra marco puerta
8	Escuadra hoja puerta
12	Esquadra alineamiento
1	Cremona fundición
1	Kits cremona una hoja para cámara Europea
1	Kits pasadores segunda hoja para cámara Europea
1	Juego tapas inversor
2	Defector salida agua
2L + 4H	Junta central
2L + 4H	Junta batiente

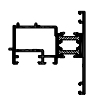

# Abisagrada C.E. Serie CM-53RT CAP

Secciones y hoja de corte

Ventana de dos hojas practicables.

PERFIL	CODIGO	POSICION	UNIDADES	CORTE	MEDIDA
	553140	Horizontal	2		= L
		Vertical	2		= H
		Horizontal	4		L/2 - 26,5 mm.
	553340	Vertical	4		H - 48 mm.
	553504	Vertical	1		H - 112
	850022	Vertical	1		Segun modelo cremona y sus accesorios
		Horizontal	4		A - 93 mm.
	553021	Vertical	4		B - 137 mm.

ACCESORIOS

UNIDADES	DESCRIPCION
4	Bisagra cámara Europea
12	Escuadra marco y hoja ventana
12	Escuadra alineamiento
1	Cremona fundición
1	Kits cremona una hoja para cámara Europea
1	Kits pasadores segunda hoja para cámara Europea
1	Juego tapas inversor
2	Deflector salida agua
2L + 4H	Junta central
2L + 4H	Junta batiente

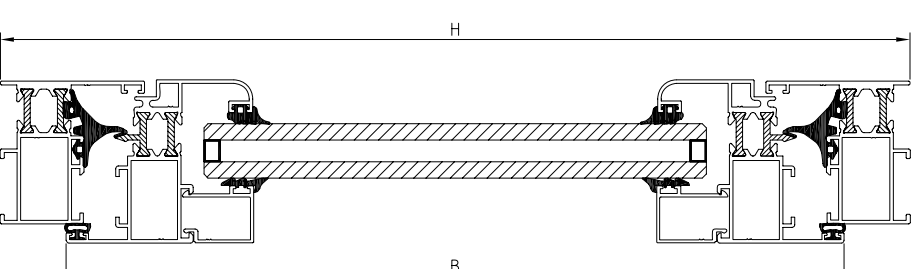
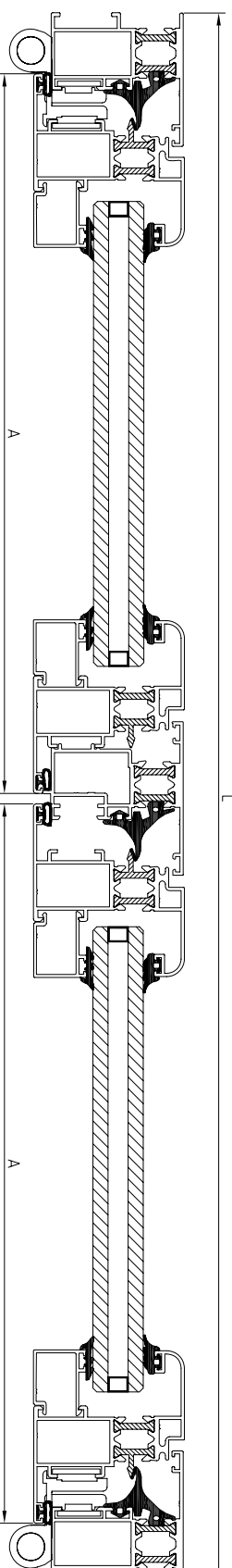















# Abisagrada C.E. serie CM53-RT

Secciones y hoja de corte

## Ventana pivotante de eje horizontal

PERFIL	CODIGO	POSICION	UNIDADES	CORTE	MEDIDA
	553140	Horizontal	2		= L
		Vertical	2		= H
	553371	Horizontal	2		L - 50
		Vertical	2		H / 2 - 25
	553370	Vertical	1		H - 116
		Horizontal	2		L - 116
	553021	Horizontal	2		A - 132
		Vertical	2		B - 176

## Accesorios

UNIDADES	DESCRIPCION
1	Juego bisagras giro pivotante para cámara europea
8	Escuadra marco e Inversor pivotante
4	Escuadra hoja pivotante
16	Escuadra alineamiento
1	Cremona presión
2	Defector salida agua
4L + 4H	Junta batiente

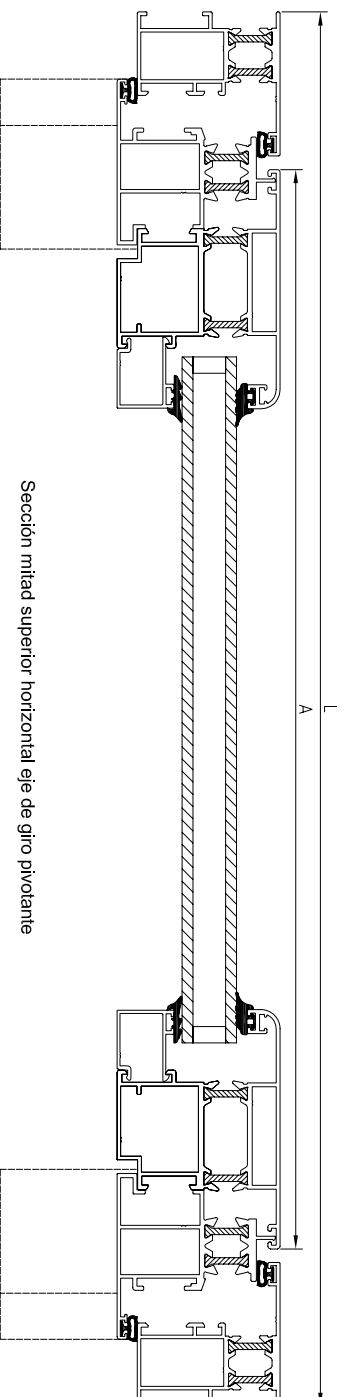

Sección mitad superior horizontal eje de giro pivotante

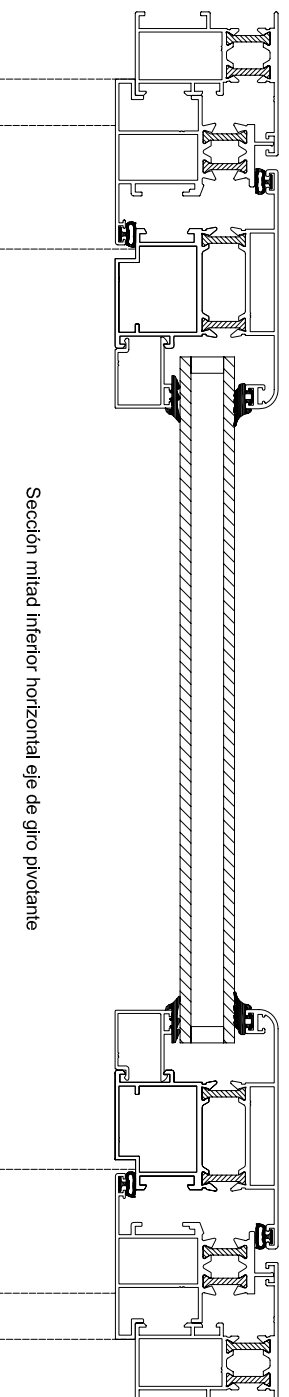

Sección mitad inferior horizontal eje de giro pivotante

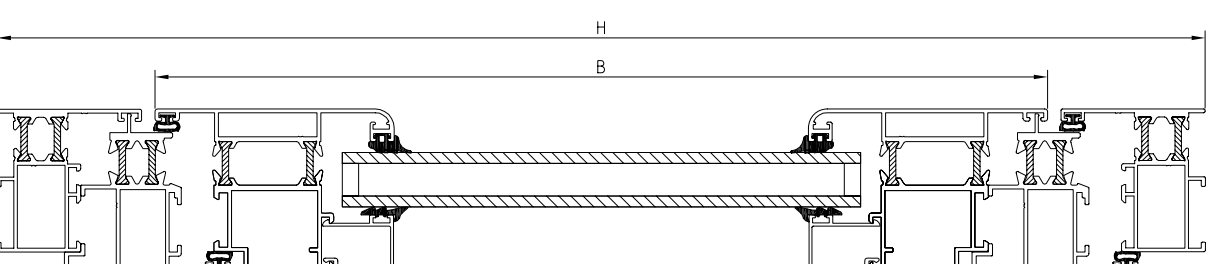

# Abisagrada CE CM-53RT

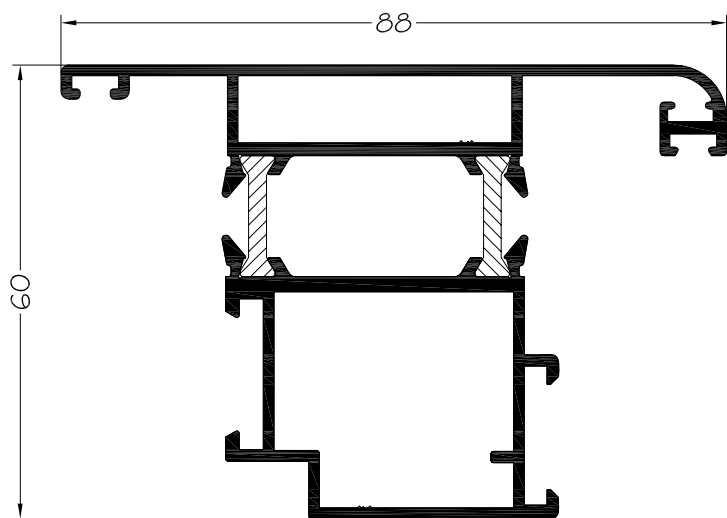

553370

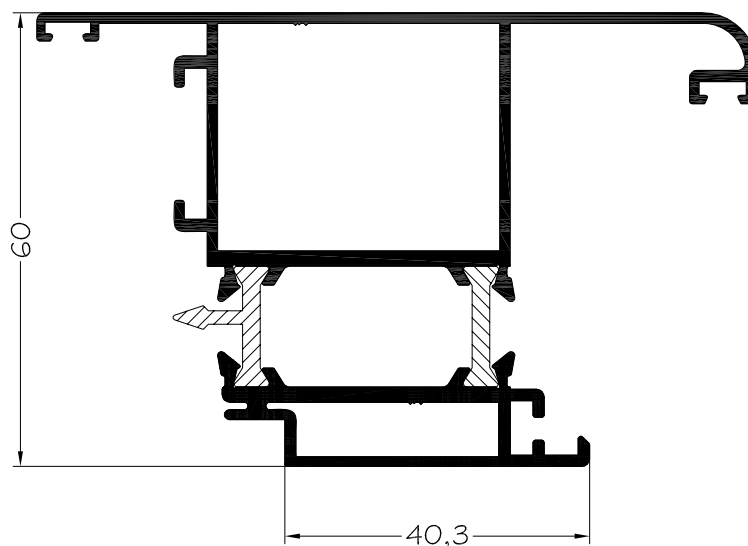

553358

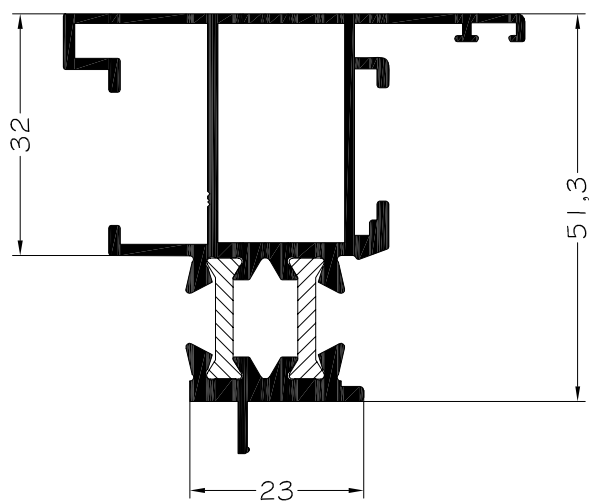

553371



553763

# Abisagrada CE CM-53RT

553113

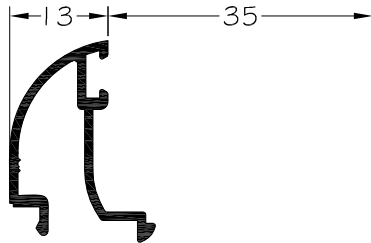

553116

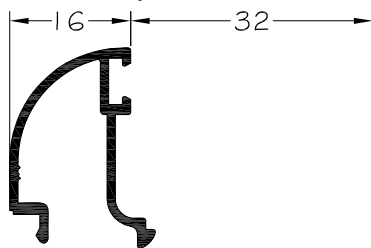

553121

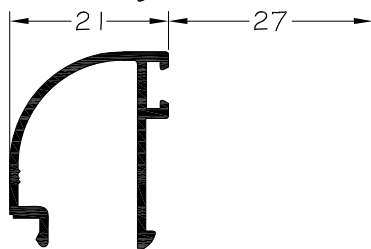

553125

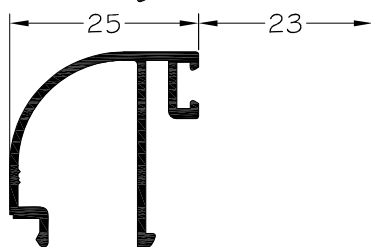

553128

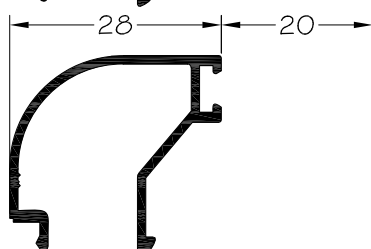

553133

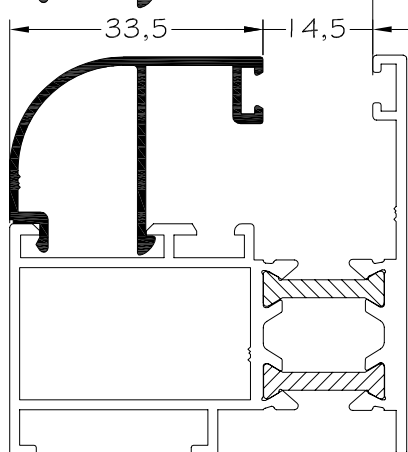

553213

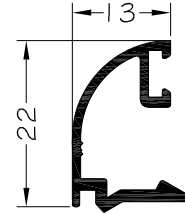

553216

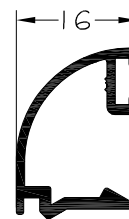

553221

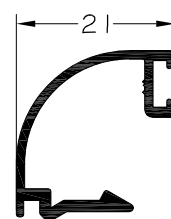

553225

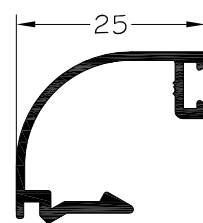

553228

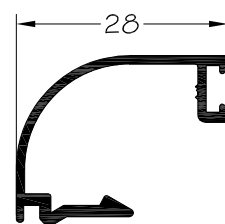

553233

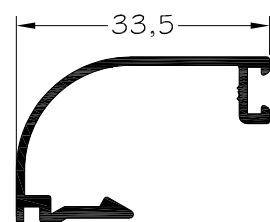

GALCES TAMBIEN VALIDOS PARA HOJA DE 60 CURVA

# Abisagrada CE CM-53RT

553004

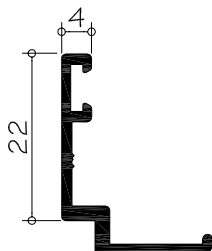

553021

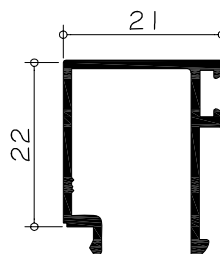

553008

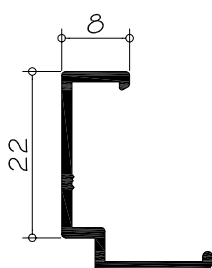

553025

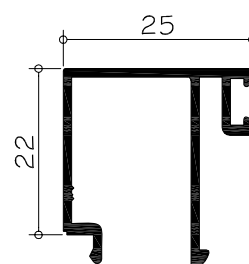

553016

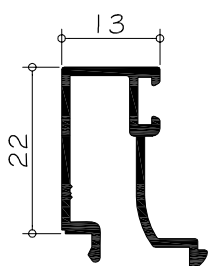

553029

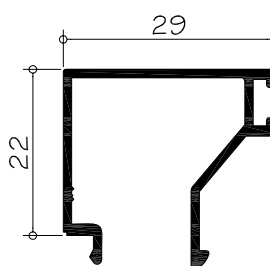

553016

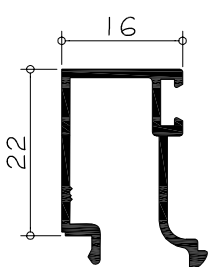

553033

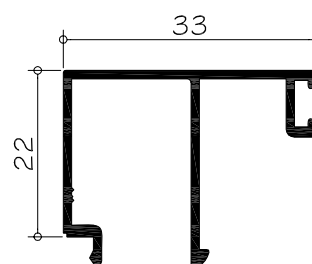

# Abisagrada CE CM-53RT

(perfiles para curvar)

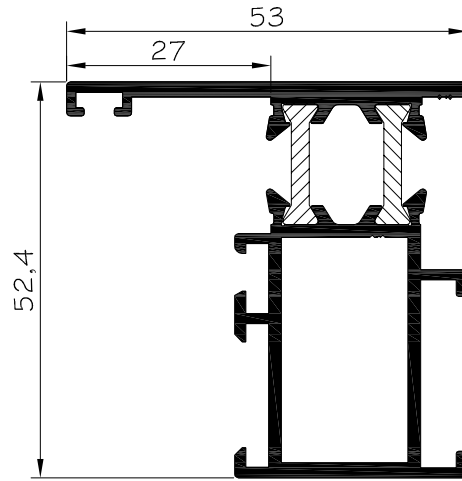

**553143**

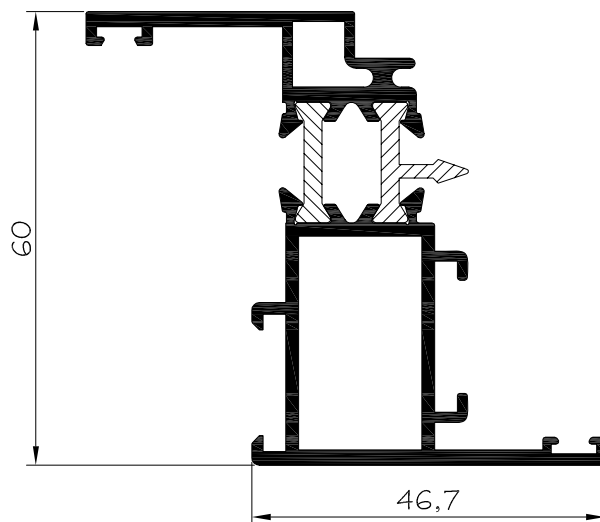

**553339**

# Abisagrada CE CM-53RT

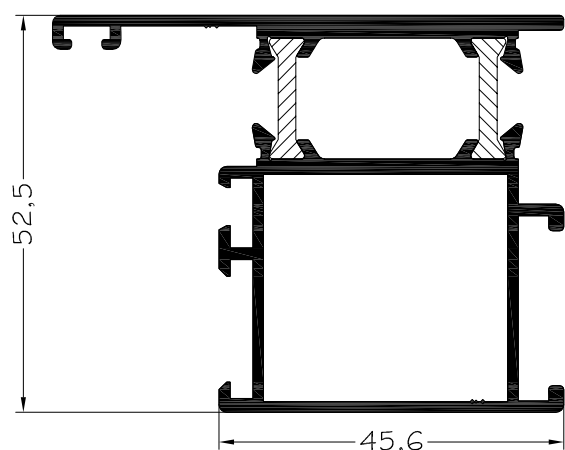

**553144**

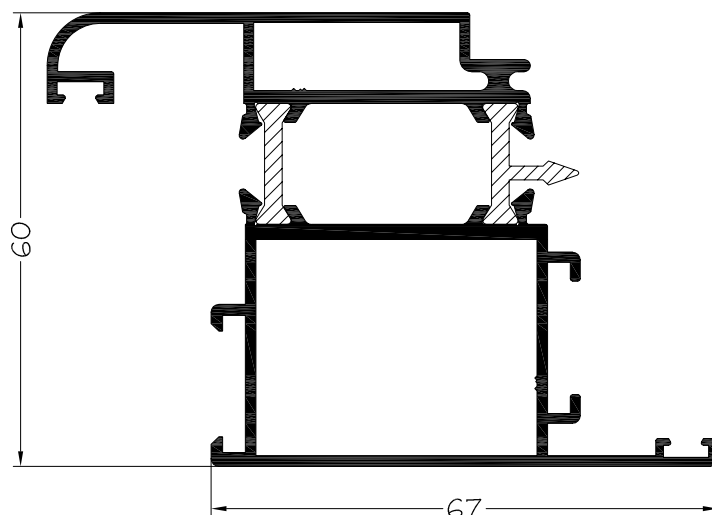

**553341**

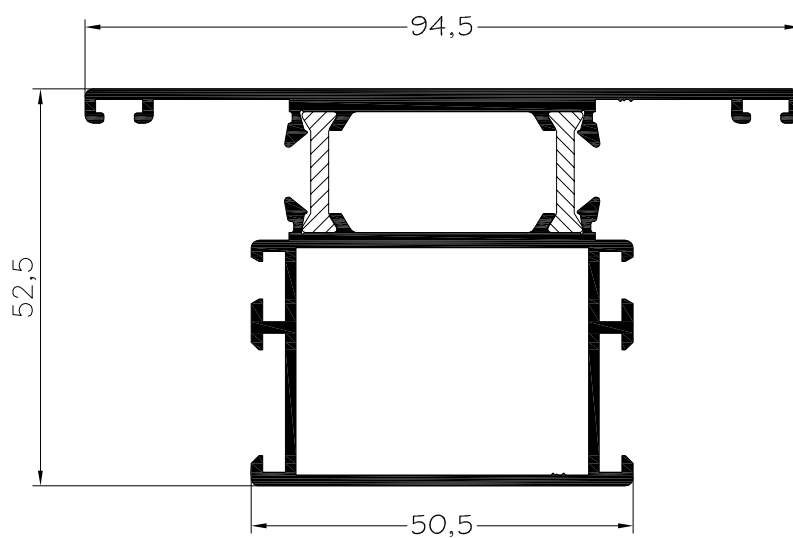

**553719**

# Abisagrada CE CM-53RT

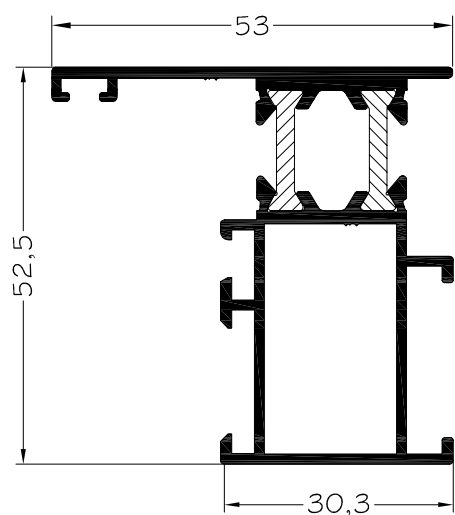

**553140**

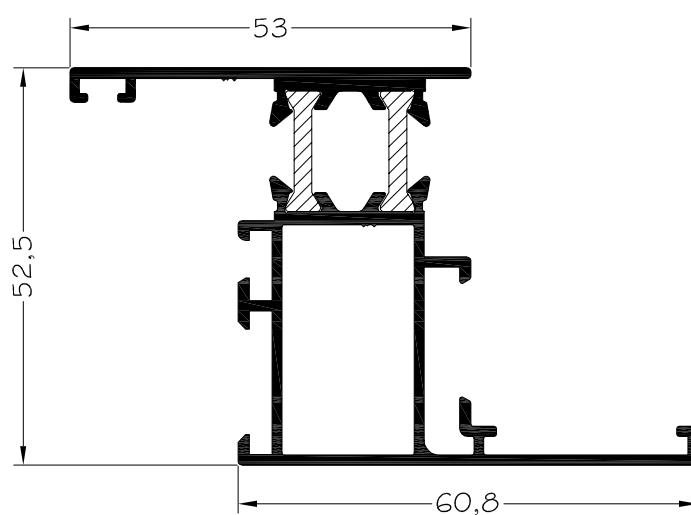

**553141**

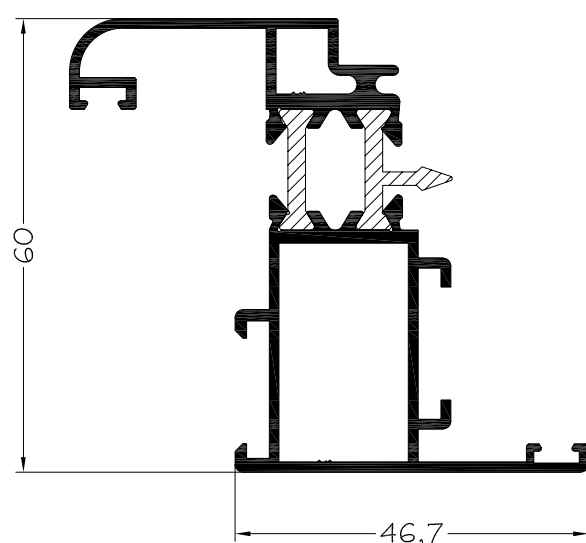

**553340**

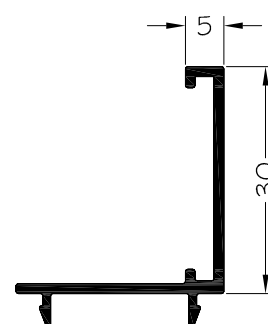

**553809**

# Abisagrada CE CM-53RT

## Secciones nudos

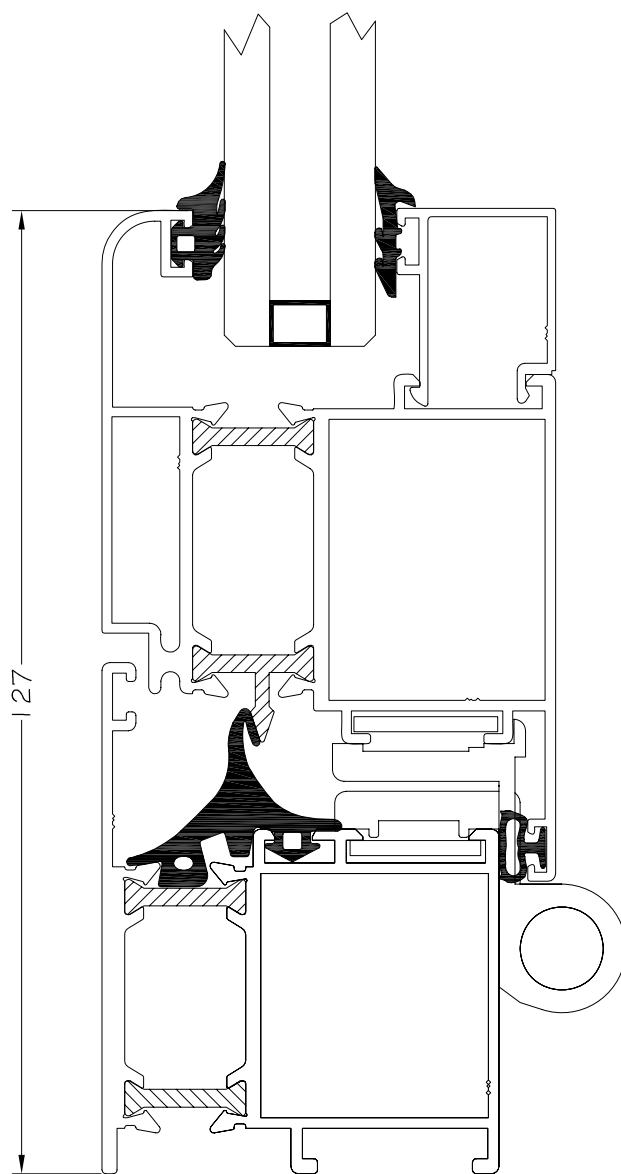
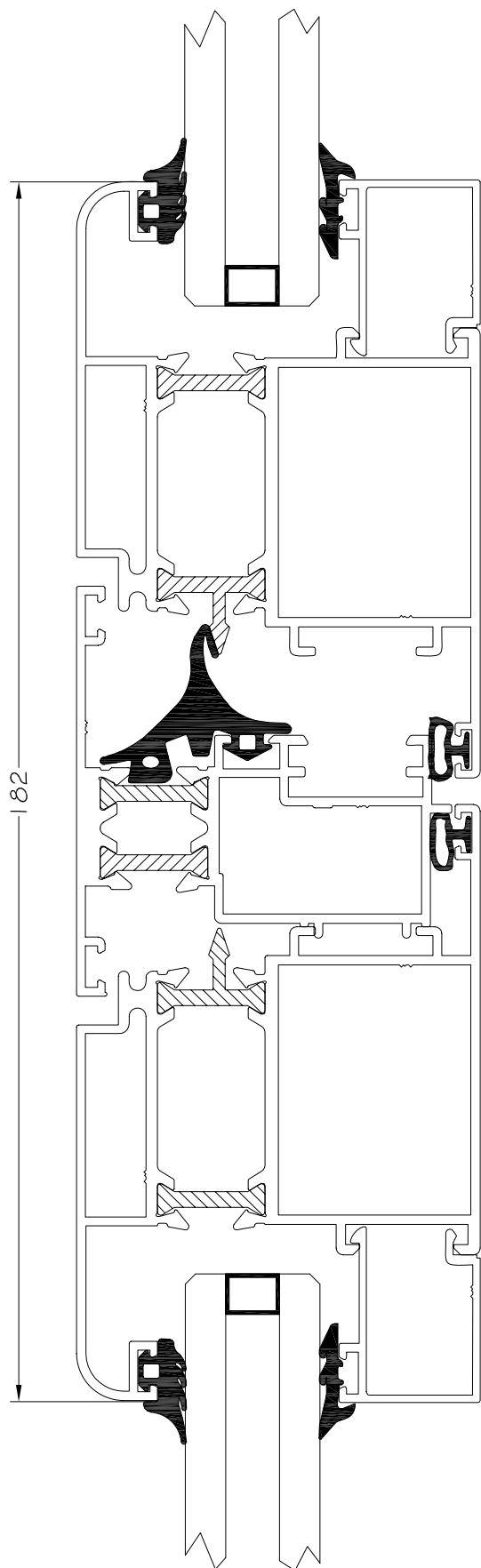



# Abisagrada CE CM-53RT

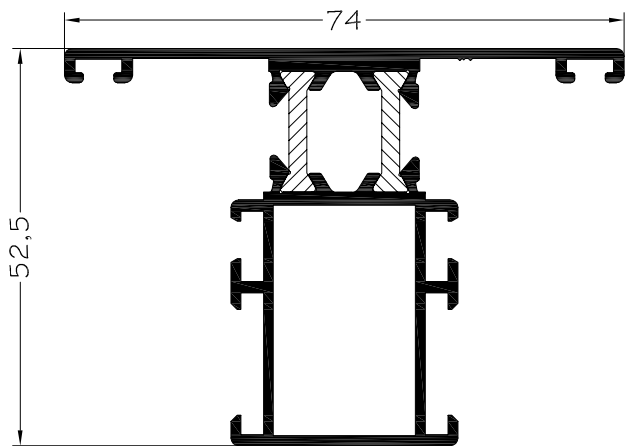

553705

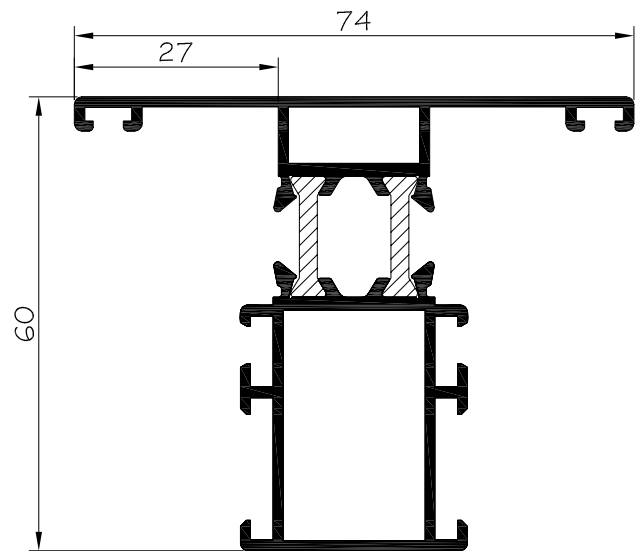

553706

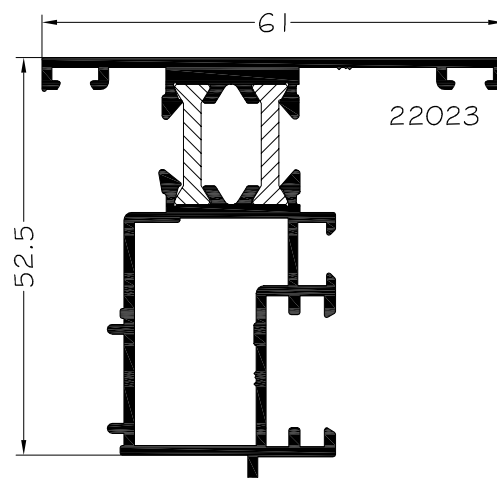

553504